

Supreme Metal

A Complete Family of Quality Products

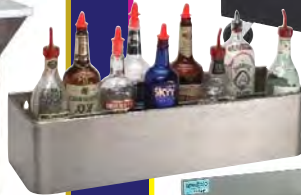

Ordering Made Simple



Call us :

800-645-2526

(770) 740-6000

8am-4:30pm Eastern

Monday-Friday



Fax us :

770-740-6010

24 hours a day

Questions??

Contact us:



Internet:

info@suprememetal.com

www.suprememetal.com

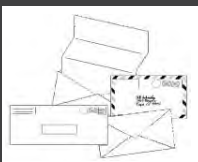

Mail:

3125 Trotters Pkwy

Alpharetta, GA

30004-7746

Table of Contents

Accessories	48 & 49
Accessories (Hot Food)	16
Accessories (Prestige)	33
Bar Sinks -Prestige	21
Bar Sinks-Slimline/Challenger series	34
Beer Baths	5
Beer Drainers -Prestige	28
Beer Drainers -Slimline/Challengers series	41
Buffet Tables	8 & 9
Cocktail Workstations -Slimline/Challengers series	39
Cold Pan Tables	15
Combo Bar Sinks-Slimline/Challengers series	35
Drainboards -Prestige	28
Drainboards -Slimline/Challengers series	41
Drop-In Cold Pan units	14
Drop-In Sealed Wells	14
Drop-ins	3 & 4
Electric Hot Food Tables	10
Fillers -Prestige	31
Fillers -Slimline/Challengers series	45
Frozen Drink Stand -Prestige	25
Frozen Drink Stand -Slimline/Challengers series	43
Gas Hot Food Tables	12
Glass Racks -Prestige	29
Glass Racks -Slimline/Challengers series	44
Hand Sinks -Prestige	27
Hand Sinks -Slimline/Challengers series	40 & 42
Hot Food Table Parts	17
Hot Food Tables	10 - 17
Ice Bins -Prestige	22
Ice Bins -Slimline/Challengers series	36
Ice Bins with Cold Plates -Prestige	23
Ice Bins with Cold Plates -Slimline/Challengers series	37
Ice Cream Cabinet -Prestige	26
Ice Cream Cabinet -Slimline/Challengers series	40
Liquor Display -Slimline/Challengers series	44
Liquor Racks -Prestige	30
Modular Bar Die System	18 & 19
Overshelves -Prestige	24
Overshelves -Slimline/Challengers series	38
Pass Thru Cocktail Station -Prestige	24
Pass Thru Cocktail Station -Slimline/Challenger	38
Portable Bars	6 & 7
Portable Cash Register Stand	7
Portable Ice Bin -Prestige	25
Portable Ice Bins -Slimline/Challengers series	39
Quick Pricing Guide	52-65
Recessed Glass Shelves -Prestige	29
Representatives	50 & 51
Sealed Well Hot Food Tables	11
Service Units -Prestige	27
Solid Top Tables	15
Speed Rails	46 & 47
Speed Rails -Prestige	32
Super Servs -Slimline/Challengers series	42 & 43
Trash Receptacle -Prestige	25
Trash Receptacle -Slimline/Challengers series	43
Uni-Servs -Prestige	26
Uni-Servs -Slimline/Challengers series	39
Warranty Information (General)	Back Cover
Warranty Information (Triumph Line)	17
Wet / Dry Waste Cabinet -Slimline/Challengers series	41
Wet / Dry Waste Cabinets -Prestige	30
Wetbath Tables	13

Supreme Metal drop-ins include: ice bins, with or without cold plates, water stations and hand sinks alone or in combination units. Ice bins have 1" diameter drains & 1/2" diameter drains on cold plate units. Ice bin units are supplied with a hinged stainless steel cover and are manufactured with a rubber thermal breaker to reduce condensation. Hand sink models are supplied with 3 1/2" basket drains, and a 4" deck faucet with 6" spout. It offers Hot & Cold with 1/2" I.P.S. The water filler has a 1" diameter drain in the drip pan and the faucet has a cold connection with 1/2" I.P.S.

Serving stations can be cut out to accept all Drop-ins. Specify the location: left, center or right, and add the cut out charge that applies.

All drop-in ice bins are foam in place insulated.

Model	Description	Outside Dimensions	Cut-Out size	Wgt.	Ice Capacity	List Price
D-12-IBL	insulated ice bin	12 x 18	15 3/8" x 9 3/4"	22lbs	23lbs	\$518
D-24-IBL	insulated ice bin	21 1/4 x 18	20 3/8" x 15 1/4"	35lbs	50lbs	\$680
D-30-IBL	insulated ice bin	27 1/4 x 18	26 3/8" x 15 1/4"	42lbs	62lbs	\$803
D-36-IBL	insulated ice bin	33 1/4 x 18	32 3/8" x 15 1/4"	48lbs	75lbs	\$923
D-24-IBL-7	ice bin w/ cold plate	21 1/4 x 18	20 3/8" x 15 1/4"	70lbs	50lbs	\$1837
D-30-IBL-7	ice bin w/ cold plate	27 1/4 x 18	26 3/8" x 15 1/4"	77lbs	62lbs	\$1956
D-36-IBL-7	ice bin w/ cold plate	33 1/4 x 18	32 3/8" x 15 1/4"	83lbs	75lbs	\$2079
D-12-WSL	water station	12 x 18	15 3/8" x 9 3/4"	12lbs	n/a	\$408
D-12-HSL	hand sink	12 x 18	15 3/8" x 9 3/4"	13lbs	n/a	\$468
D-24-WSIBL	water station / ice bin	21 1/4 x 18	20 3/8" x 15 1/4"	30lbs	23lbs	\$905
D-24-WSIBL2	water station / ice bin	21 1/4 x 18	20 3/8" x 15 1/4"	47lbs	50lbs	\$1086
D-24-SIBL	hand sink / ice bin	21 1/4 x 18	20 3/8" x 15 1/4"	30lbs	23lbs	\$970
D-12	replacement cover small			4lbs	n/a	\$51
D-24	replacement cover large			6lbs	n/a	\$84



Drop-Ins



Ice Bin w/ Water Filler Faucet

High volume ice and water station. Drainer grate on both sides.
Dual push back water filler faucet and side splashes.

Designed for counter top drop-in use.



D-IBWF3

Model	Description	Outside Dimensions	Cut-Out size	Wgt.	Ice Capacity	List Price
D-IBWF3	3' ice bin with 2 water filler Faucet & drain pans	36" x 29" x 14"	30" x 16"	70	89 lbs.	\$1736
D-IBWF4	4' ice bin with 2 water filler Faucet & drain pans	48" x 29" x 14"	42" x 16"	80	127 lbs.	\$1960
D-IBWF3-8	3' ice bin with 2 water filler Faucet & drain pans with 8 circuit cold plate	36" x 29" x 14"	30" x 16"	140	89 lbs.	\$3085
D-IBWF4-8	4' ice bin with 2 water filler Faucet & drain pans with 8 circuit cold plate	48" x 29" x 14"	42" x 16"	150	127 lbs.	\$3310

Drop-in Bar Sinks

FEATURES:

- 10" x 14" x 10" sink bowls
- 1-1/2" I.P.S. drains
- Faucet included



DBS-2

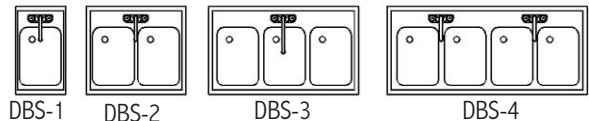

Model	Description	Outside Dimensions	Cut-Out Size	Wgt.	List Price
Drop-In sinks with faucet included on unit.					
DBS-1	1 well drop-in sink	20" x 12"	17" x 11"	15	\$482
DBS-2	2 well drop-in sink	20" x 24"	17" x 23"	30	\$643
DBS-3	3 well drop-in sink	20" x 36"	17" x 35"	45	\$837
DBS-4	4 well drop-in sink	20" x 48"	17" x 47"	60	\$1060
Drop-In sinks with drainboards and a separate faucet to be mounted on countertop.					
DBS-42C	2 wells with 2(ea) 12" drainboards	20" x 48"	17" x 46"	40	\$1029
DBS-43L	3 wells with a 12" drainboard on the Right	20" x 48"	17" x 46"	50	\$1157
DBS-43R	3 wells with a 12" drainboard on the Left	20" x 48"	17" x 46"	50	\$1157
DBS-53C	3 wells with 2(ea) 12" drainboards	20" x 60"	17" x 58"	60	\$1285
DBS-63C	3 wells with 2(ea) 18" drainboards	20" x 72"	17" x 70"	70	\$1413
DBS-64C	4 wells with 2(ea) 12" drainboards	20" x 72"	17" x 70"	80	\$1543

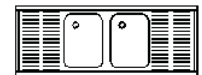

DBS-42C

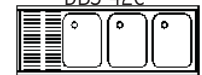

DBS-43R



DBS-43L



DBS-53C

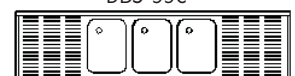

DBS-63C



DBS-64C

Toll Free : 800-645-2526 Call Today!

Challenger Series

Extra deep ice bin for icing down bottled beer.
 Perfect for high volume locations. Available in 4' and 5' sizes!
 All units supplied with stainless steel perforated false bottom to allow melted ice to drain.

*Optional locking cover model is available to secure bottles at night. (Cover can't be used during normal operation)



CRBB-48

Model	Description	List Price	Wgt.	Cu. Ft.
CRBB-48	48" beer bath - extra deep ice bin for icing down beer Interior Ice Bin size - 45 ³ / ₄ "(length) x 20 ³ / ₄ "(width) x 18" (deep)	\$1804	130	14
CRBB-60	60" extra deep ice bin for icing down beer Interior Ice Bin size - 57 ³ / ₄ "(length) x 20 ³ / ₄ "(width) x 18" (deep)	\$1932	163	15
Beer Bath with Locking Cover				
CRBB-48-LC	48" beer bath - extra deep ice bin for icing down beer Interior Ice Bin size - 45 ³ / ₄ "(length) x 20 ³ / ₄ "(width) x 18" (deep) Stainless steel locking cover with 2 locks.	\$2026	136	14
CRBB-60-LC	60" extra deep ice bin for icing down beer Interior Ice Bin size - 57 ³ / ₄ "(length) x 20 ³ / ₄ "(width) x 18" (deep) Stainless steel locking cover with 2 locks.	\$2304	170	15



CRBB-48-LC
Shown with locking cover.

Prestige Series Beer Bath

Standard Features for the Prestige Beer Bath:

- Stainless steel construction
- Mirrored front molding
- Black polyethylene thermal breaker marine edge

Model	Description	List Price	Wgt.	Cu. Ft.
PRBB-48	48" beer bath - extra deep ice bin for icing down beer Interior Ice Bin size - 45 ³ / ₄ "(length) x 20 ³ / ₄ "(width) x 18" (deep)	\$2254	135	14
PRBB-60	60" extra deep ice bin for icing down beer Interior Ice Bin size - 57 ³ / ₄ "(length) x 20 ³ / ₄ "(width) x 18" (deep)	\$2416	169	15
Beer Bath with Locking Cover				
PRBB-48-LC	48" beer bath - extra deep ice bin for icing down beer Interior Ice Bin size - 45 ³ / ₄ "(length) x 20 ³ / ₄ "(width) x 18" (deep) Stainless steel locking cover with 2 locks.	\$2476	135	14
PRBB-60-LC	60" extra deep ice bin for icing down beer Interior Ice Bin size - 57 ³ / ₄ "(length) x 20 ³ / ₄ "(width) x 18" (deep) Stainless steel locking cover with 2 locks.	\$2683	169	15

Accessories

A-55 Removable dividers to separate beer \$84 ea.

Portable Bars



FEATURES:

Designed for light-duty use by small hotels, VFW halls and catering facilities.

- Melamine Construction
- Top-Black (standard finish)
- Body-Black (standard finish)
- Ice Bin 18" x 14" x 10" deep drawn complete with drain & shut-off valve
- Dual speed rails to hold up to 10 bottles of liquor
- Open bottom shelf for glass rack storage
- 4 ea. 4" swivel casters (2 ea. Locking)

5' Marquis



M-B

Marquis Features:

- ABS molded work top
- Black plastic speed rails
- Black Finish
- Towel ring

Model	Mica Finish	List Price	Wgt.	Cu.Ft.
M-B	Black	\$1680	200	49

5' Duchess



D-B

Duchess Features:

- Stainless steel flat work top
- Stainless steel speed rails
- 7 circuit post mix cold plate available (s/s bottom included)
- Towel ring

Model	Mica Finish	List Price	Wgt.	Cu.Ft.
D-B	Black	\$2252	210	49
<i>With 7-Circuit Post Mix Cold Plate</i>				
D-B-7	Black	\$3666	260	49

8' Regency



R-8-B

Designed for High Volume and/or Dual Operator Capabilities.

- Constructed of 3/4" plywood with mica laminate
- Available in Black finish
- Corrugated stainless steel work surface, back and side splashes
- Stainless steel bottom for strength and durability
- 2 ice bins 19" x 13 1/2" x 11" deep, with drain & shut-off valve (located at each end)
- Stainless steel speed rails
- 4 ea. 6" heavy duty swivel casters (2 locking)
- 7 circuit post mix cold plate available, installed in right side ice bin

Model	Mica Finish	List Price	Wgt.	Cu.Ft.
R-8-B	Black	\$6904	700	117
<i>With 7 Circuit Post Mix Cold Plate</i>				
R-8-B-7	Black	\$8318	750	117

Portable Bar Options

Available for the Marquis, Duchess, & Regency portable bars.

THREE SIDED CONTINUOUS BUMPER - Model # A-73 \$675

CUSTOM MICA COLORS - Model # A-74 \$1155 EACH BAR - Custom colors include exterior finishes only, bar front, doors and bar top. All interiors are standard black finish. Please specify when ordering.



Toll Free : 800-645-2526 Call Today!

5' & 6' Ambassador Bar

Designed for heavy-duty use by hotels and convention centers.

- All stainless steel construction (*interior, doors and bottom*)
- Ice Bin - 19" x 13 1/2" x 11" deep (*ice bin on right side on 5' bar*)
- Top-black mica
- Body-black mica (*standard*)
- BK style speed rails
- Bumpers - full perimeter
- 6" Locking Casters - heavy duty

**CHOOSE
YOUR OWN
CUSTOM
COLOR!**



AMS-5B



AMD-6B

Choice of Custom Color (Free Upgrade)

Choose from a wood grain or solid color (matte finish) for the body of the bar at no additional charge, the bar top will be the standard black finish. For any textured or embossed mica the price is determined upon application. Supply us with the Color, Manufacturer, and Style (model) number at the time the order is placed.

Model	Description	List Price	Wgt.	Cu. Ft.
AMS-5B	5' Open Front with BK speedrails	\$4314	315	50
AMD-5B	5' Closed Front with S/S Doors and BK speedrails	\$4811	340	60
AMS-6B	6' Open Front with BK speedrails	\$4794	350	60
AMD-6B	6' Closed Front with S/S Doors and BK speedrails	\$5291	370	60
<i>With 7 Circuit Post Mix Cold Plate</i>				
AMS-5B-7	5' Open Front with BK speedrails & CP-7	\$5727	365	50
AMD-5B-7	5' Closed Front with S/S Doors, BK speedrails & CP-7	\$6224	400	60
AMS-6B-7	6' Open Front with BK speedrails & CP-7	\$6207	420	60
AMD-6B-7	6' Closed Front with S/S Doors, BK speedrails & CP-7	\$6704	420	60

Note: Consult factory for other portable bar configurations not shown.

2' Portable Cash Register Stand

2' portable cash register stand with flat top is supplied with a locking door, mid shelf, continuous bumper and 6" casters. This unit complements any of the Ambassador portable bars. This model has a standard black finish, custom colors are available.

Model	List Price	Wgt.	Cu. Ft.
AMD-2B	\$1543	160	25.5



AMD-2B

Buffet Tables



FEATURES:

- 6' electrical cord with plug
- Infinite control knobs
- Indicator lights
- Single phase wiring
- 500 watt elements (120 volt)
- 1000 watt elements (240 volt)
- Fiberglass insulation between each compartment
- 4" swivel casters, with two brakes
- Sneeze Guard
- Tray Shelf

Hot food Portable Buffet is available with two - five well openings. Supplied with stainless steel tray rail, casters and Lexan® sneeze guard. Choose from Granite or Black Vinyl Clad finish.

Length of Units:	
2 Well	31 13/16"
3 Well	47 1/8"
4 Well	62 3/8"
5 Well	77 3/4"



B3-120-G shown.



Electric Buffet Tables

Black Buffet Table w/ Open Base

120V Model #	Amps/ Watts	208V Model #	Amps/ Watts	240V Model #	Amps/ Watts	List Price	Wgt.
B2-120-B	15/500	B2-208-B	15/750	B2-240-B	20/1000	\$2698	145
B3-120-B	15/500	B3-208-B	15/750	B3-240-B	20/1000	\$2957	190
B4-120-B	20/500	B4-208-B	20/750	B4-240-B	30/1000	\$3471	240
		B5-208-B	20/750	B5-240-B	30/1000	\$4242	295

Granite Buffet Table w/ Open Base

120V Model #	Amps/ Watts	208V Model #	Amps/ Watts	240V Model #	Amps/ Watts	List Price	Wgt.
B2-120-G	15/500	B2-208-G	15/750	B2-240-G	20/1000	\$2698	145
B3-120-G	15/500	B3-208-G	15/750	B3-240-G	20/1000	\$2957	190
B4-120-G	20/500	B4-208-G	20/750	B4-240-G	30/1000	\$3471	240
		B5-208-G	20/750	B5-240-G	30/1000	\$4242	295

Black Buffet Table w/ Stainless Steel Wells and Open Base

120V Model #	208V Model #	240V Model #	List Price	Wgt.
B2-120-B-S	B2-208-B-S	B2-240-B-S	\$2802	145
B3-120-B-S	B3-208-B-S	B3-240-B-S	\$3111	190
B4-120-B-S	B4-208-B-S	B4-240-B-S	\$3676	240
	B5-208-B-S	B5-240-B-S	\$4498	295

Granite Buffet Table w/ Stainless Steel Wells and Open Base

120V Model #	208V Model #	240V Model #	List Price	Wgt.
B2-120-G-S	B2-208-G-S	B2-240-G-S	\$2802	145
B3-120-G-S	B3-208-G-S	B3-240-G-S	\$3111	190
B4-120-G-S	B4-208-G-S	B4-240-G-S	\$3676	240
	B5-208-G-S	B5-240-G-S	\$4498	295

Black Buffet Table w/ Solid Base

120V Model #	208V Model #	240V Model #	List Price	Wgt.
B2-120-B-SB	B2-208-B-SB	B2-240-B-SB	\$2764	150
B3-120-B-SB	B3-208-B-SB	B3-240-B-SB	\$3052	195
B4-120-B-SB	B4-208-B-SB	B4-240-B-SB	\$3599	245
	B5-208-B-SB	B5-240-B-SB	\$4403	300

Granite Buffet Table w/ Solid Base

120V Model #	208V Model #	240V Model #	List Price	Wgt.
B2-120-G-SB	B2-208-G-SB	B2-240-G-SB	\$2764	150
B3-120-G-SB	B3-208-G-SB	B3-240-G-SB	\$3052	195
B4-120-G-SB	B4-208-G-SB	B4-240-G-SB	\$3599	245
	B5-208-G-SB	B5-240-G-SB	\$4403	300

Black Buffet Table w/ Stainless Steel Wells and Solid Base

120V Model #	208V Model #	240V Model #	List Price	Wgt.
B2-120-B-S-SB	B2-208-B-S-SB	B2-240-B-S-SB	\$2867	150
B3-120-B-S-SB	B3-208-B-S-SB	B3-240-B-S-SB	\$3207	195
B4-120-B-S-SB	B4-208-B-S-SB	B4-240-B-S-SB	\$3804	245
	B5-208-B-S-SB	B5-240-B-S-SB	\$4659	300

Granite Buffet Table w/ Stainless Steel Wells and Solid Base

120V Model #	208V Model #	240V Model #	List Price	Wgt.
B2-120-G-S-SB	B2-208-G-S-SB	B2-240-G-S-SB	\$2867	150
B3-120-G-S-SB	B3-208-G-S-SB	B3-240-G-S-SB	\$3207	195
B4-120-G-S-SB	B4-208-G-S-SB	B4-240-G-S-SB	\$3804	245
	B5-208-G-S-SB	B5-240-G-S-SB	\$4659	300



HOT FOOD TABLES

FEATURES:

- 4" swivel casters, with two brakes
- Sneeze Guard
- Tray Shelf

Perfect companion for the hot food unit. These units can be ice-cooled to display desserts, fruits or cold drinks.



Buffet Tables



B3-240-B-SB shown with Heat Lamp option.

Buffet Cold Pan Tables

Black w/ Open Base

Model #	List	
	Price	Wgt.
B2-CPU-B	\$2442	168
B3-CPU-B	\$2829	193
B4-CPU-B	\$3213	242
B5-CPU-B	\$3599	269

Black w/ Solid Base

Model #	List	
	Price	Wgt.
B2-CPU-B-SB	\$2507	173
B3-CPU-B-SB	\$2924	198
B4-CPU-B-SB	\$3342	247
B5-CPU-B-SB	\$3759	275

Granite w/ Open Base

Model #	List	
	Price	Wgt.
B2-CPU-G	\$2442	168
B3-CPU-G	\$2829	193
B4-CPU-G	\$3213	242
B5-CPU-G	\$3599	269

Granite w/ Solid Base

Model #	List	
	Price	Wgt.
B2-CPU-G-SB	\$2507	173
B3-CPU-G-SB	\$2924	198
B4-CPU-G-SB	\$3342	247
B5-CPU-G-SB	\$3759	275

Buffet Solid Top Tables

Black w/ Open Base

Model #	List	
	Price	Wgt.
B2-STU-B	\$2185	168
B3-STU-B	\$2570	193
B4-STU-B	\$2957	242
B5-STU-B	\$3342	269

Black w/ Solid Base

Model #	List	
	Price	Wgt.
B2-STU-B-SB	\$2250	173
B3-STU-B-SB	\$2667	198
B4-STU-B-SB	\$3085	247
B5-STU-B-SB	\$3502	275

Granite w/ Open Base

Model #	List	
	Price	Wgt.
B2-STU-G	\$2185	168
B3-STU-G	\$2570	193
B4-STU-G	\$2957	242
B5-STU-G	\$3342	269

Granite w/ Solid Base

Model #	List	
	Price	Wgt.
B2-STU-G-SB	\$2250	173
B3-STU-G-SB	\$2667	198
B4-STU-G-SB	\$3085	247
B5-STU-G-SB	\$3502	275

Cash Register / Silverware Stand



Black Cash Register Stand

Model #	List	
	Price	Wgt.
BCRS-B	\$1543	45

Granite Cash Register Stand

Model #	List	
	Price	Wgt.
BCRS-G	\$1543	45



Black Silverware Stand

Model #	List	
	Price	Wgt.
BSWS-B	\$2056	40

Granite Silverware Stand

Model #	List	
	Price	Wgt.
BSWS-G	\$2056	40

Accessories

Heat Lamp Assembly-Installed

Heat lamps installed and prewired on Buffet Tables. Separate cord and 120 volt plug supplied. Lamps finished in black only. Supplied with 250 Watt bulb. Shown above.

Model #	List
HL-2\$1166
HL-3\$1749
HL-4\$2332
HL-5\$2915

Solid Tray Shelf

Model #	List	Wgt.
TTS-2\$34515 lbs.
TTS-3\$38417 lbs.
TTS-4\$45819 lbs.
TTS-5\$57321 lbs.

Tubular Tray Rail

Model #	List	Wgt.
TTR-2\$41212 lbs.
TTR-3\$45814 lbs.
TTR-4\$53716 lbs.
TTR-5\$66719 lbs.

Stainless End Shelf

BES-2\$25710 lbs.
-------	------------	--------------

Electric Hot Food Tables



HOT FOOD TABLES

FEATURES:

- 6' electrical cord with plug
- Infinite control knobs
- Indicator lights
- Single phase wiring
- Stainless steel undershelf.
- Fiberglass insulation between each compartment
- 1" thick poly cutting board (8" wide)
- New 1000 WATT elements standard on 240V units
- For portable units add **\$292 list** and prefix "P" to the model number.
- 5" swivel casters, with two brakes on portable units
- Universal mount push handle (right/left), on portable units

Sectional View of Hot Food Table

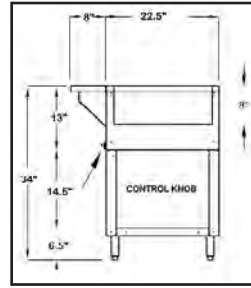

See page 17 for 3 phase wiring and NEMA plug info.

Length of Units:

2 Well	31 13/16"
3 Well	47 1/8"
4 Well	62 3/8"
5 Well	77 3/4"



Electric Table



HF-2E-120/208/240

120V Model #	Amps/Watts	208V Model #	Amps/Watts	240V Model #	Amps/Watts	List Price	Wgt.
HF-2E-120	15/500	HF-2E-208	20/750	HF-2E-240	20/1000	\$1316	92
HF-3E-120	15/500	HF-3E-208	20/750	HF-3E-240	20/1000	\$1417	120
HF-4E-120	30/500	HF-4E-208	20/750	HF-4E-240	30/1000	\$2020	152
		HF-5E-208	30/750	HF-5E-240	30/1000	\$2529	170

Electric tables with stainless steel liners in each well

120V Model #	Amps/Watts	208V Model #	Amps/Watts	240V Model #	Amps/Watts	List Price	Wgt.
HF-2E-120-SS	15/500	HF-2E-208-SS	20/750	HF-2E-240-SS	20/1000	\$1406	92
HF-3E-120-SS	15/500	HF-3E-208-SS	20/750	HF-3E-240-SS	20/1000	\$1612	120
HF-4E-120-SS	30/500	HF-4E-208-SS	20/750	HF-4E-240-SS	30/1000	\$2201	152
		HF-5E-208-SS	30/750	HF-5E-240-SS	30/1000	\$2753	170

Electric w/ Enclosed Base



PHF-5E-208/240-BS

Units are shown with spillage pans, spillage pans are sold separately.

120V Model #	Amps/Watts	208V Model #	Amps/Watts	240V Model #	Amps/Watts	List Price	Wgt.
HF-2E-120-BS	15/500	HF-2E-208-BS	20/750	HF-2E-240-BS	20/1000	\$2407	117
HF-3E-120-BS	15/500	HF-3E-208-BS	20/750	HF-3E-240-BS	20/1000	\$2697	145
HF-4E-120-BS	30/500	HF-4E-208-BS	20/750	HF-4E-240-BS	30/1000	\$3370	187
		HF-5E-208-BS	30/750	HF-5E-240-BS	30/1000	\$4006	205

Electric tables with stainless steel liners in each well

120V Model #	Amps/Watts	208V Model #	Amps/Watts	240V Model #	Amps/Watts	List Price	Wgt.
HF-2E-120-BS-SS	15/500	HF-2E-208-BS-SS	20/750	HF-2E-240-BS-SS	20/1000	\$2497	117
HF-3E-120-BS-SS	15/500	HF-3E-208-BS-SS	20/750	HF-3E-240-BS-SS	20/1000	\$2833	145
HF-4E-120-BS-SS	30/500	HF-4E-208-BS-SS	20/750	HF-4E-240-BS-SS	30/1000	\$3549	187
		HF-5E-208-BS-SS	30/750	HF-5E-240-BS-SS	30/1000	\$4231	205

Electric w/ Enclosed Base & Doors



PHF-5E-208/240-DR

Units are shown with spillage pans, spillage pans are sold separately.

120V Model #	Amps/Watts	208V Model #	Amps/Watts	240V Model #	Amps/Watts	List Price	Wgt.
HF-2E-120-DR	15/500	HF-2E-208-DR	20/750	HF-2E-240-DR	20/1000	\$2954	127
HF-3E-120-DR	15/500	HF-3E-208-DR	20/750	HF-3E-240-DR	20/1000	\$3309	155
HF-4E-120-DR	30/500	HF-4E-208-DR	20/750	HF-4E-240-DR	30/1000	\$4044	197
		HF-5E-208-DR	30/750	HF-5E-240-DR	30/1000	\$4745	215

Electric tables with stainless steel liners in each well

120V Model #	Amps/Watts	208V Model #	Amps/Watts	240V Model #	Amps/Watts	List Price	Wgt.
HF-2E-120-DR-SS	15/500	HF-2E-208-DR-SS	20/750	HF-2E-240-DR-SS	20/1000	\$3044	127
HF-3E-120-DR-SS	15/500	HF-3E-208-DR-SS	20/750	HF-3E-240-DR-SS	20/1000	\$3443	155
HF-4E-120-DR-SS	30/500	HF-4E-208-DR-SS	20/750	HF-4E-240-DR-SS	30/1000	\$4225	197
		HF-5E-208-DR-SS	30/750	HF-5E-240-DR-SS	30/1000	\$4970	215

Toll Free : 800-645-2526 Call Today!



HOT FOOD TABLES

Sealed Well Electric Tables

FEATURES:

- 6' electrical cord with plug
- Infinite switch
- Indicator lights
- Single phase wiring
- Stainless steel undershelf
- Fiberglass insulation between each compartment
- Drains with gate valves per well.
- 1" thick poly cutting board (8" wide)
- For portable units add \$292 list and prefix "P" to the model number.
- 5" swivel casters, with two brakes on portable units
- Universal mount push handle (right/left), on portable units



Length of Units:	
2 Well	31 13/16"
3 Well	47 1/8"
4 Well	62 3/8"
5 Well	77 3/4"



Thermostatic Controls - add the suffix **-T** to the model number and add additional pricing per the chart below.

Manifold Drains - add the suffix **-M** to the model number and add additional pricing per the chart below.

Thermostatic Controls & Manifold Drains - add the suffix **-MT** to the model number and add additional pricing per the chart below.

# Wells	2	3	4	5
List Price	194	289	386	481

# Wells	2	3	4	5
List Price	161	224	321	418

# Wells	2	3	4	5
List Price	355	513	707	899

Sealed Well Electric Table



SW-2E-120/208/240

120V Model #	Amps/Watts	208V Model #	Amps/Watts	240V Model #	Amps/Watts	List Price	Wgt.
SW-2E-120	15/640	SW-2E-208	20/825	SW-2E-240	20/1100	\$1637	92
SW-3E-120	20/640	SW-3E-208	20/825	SW-3E-240	20/1100	\$1985	120
SW-4E-120	30/640	SW-4E-208	30/825	SW-4E-240	30/1100	\$2695	152
		SW-5E-208	30/825	SW-5E-240	30/1100	\$3371	170

Sealed Well Electric w/ Enclosed Base



PSW-5E-208/240-BS

120V Model #	Amps/Watts	208V Model #	Amps/Watts	240V Model #	Amps/Watts	List Price	Wgt.
SW-2E-120-BS	15/640	SW-2E-208-BS	20/825	SW-2E-240-BS	20/1100	\$2666	117
SW-3E-120-BS	20/640	SW-3E-208-BS	20/825	SW-3E-240-BS	20/1100	\$3140	145
SW-4E-120-BS	30/640	SW-4E-208-BS	30/825	SW-4E-240-BS	30/1100	\$3980	187
		SW-5E-208-BS	30/825	SW-5E-240-BS	30/1100	\$4785	205

Sealed Well Electric w/ Enclosed Base & Doors



PSW-5E-208/240-DR

120V Model #	Amps/Watts	208V Model #	Amps/Watts	240V Model #	Amps/Watts	List Price	Wgt.
SW-2E-120-DR	15/640	SW-2E-208-DR	20/825	SW-2E-240-DR	20/1100	\$3179	127
SW-3E-120-DR	20/640	SW-3E-208-DR	20/825	SW-3E-240-DR	20/1100	\$3720	155
SW-4E-120-DR	30/640	SW-4E-208-DR	30/825	SW-4E-240-DR	30/1100	\$4622	197
		SW-5E-208-DR	30/825	SW-5E-240-DR	30/1100	\$5491	215

Gas Hot Food Tables



FEATURES:

- 3500 BTU'S Per burner
- Control knobs with 3 settings
- Pilot indicator openings
- Fiberglass insulation between each compartment
- Stainless steel undershelf on all units
- 1" thick poly cutting board (8" wide)
- Infinite control knobs
- "NAT" is natural gas, "LP" is bottled gas
- For portable units add **\$292 list** and prefix "P" to the model number.
- 5" swivel casters, with two brakes on portable units
- Universal mount push handle (right/left), on portable units

Dry Gas units are used to maintain the temperature of pre-cooked foods. These units are designed for dry operation. To keep food moist add a spillage pan with 1"- 2" of water.

Length of Units:	
2 Well	31 13/16"
3 Well	47 1/8"
4 Well	62 3/8"
5 Well	77 3/4"



Gas Table



HF-3G-NAT/LP

Natural Gas Model #	LP Gas Model #	List Price	Wgt.
HF-2G-NAT	HF-2G-LP	\$1332	92
HF-3G-NAT	HF-3G-LP	\$1602	120
HF-4G-NAT	HF-4G-LP	\$1964	152
HF-5G-NAT	HF-5G-LP	\$2360	170

Gas tables with stainless steel liners in each well

Natural Gas Model #	LP Gas Model #	List Price	Wgt.
HF-2G-NAT-SS	HF-2G-LP-SS	\$1421	92
HF-3G-NAT-SS	HF-3G-LP-SS	\$1738	120
HF-4G-NAT-SS	HF-4G-LP-SS	\$2145	152
HF-5G-NAT-SS	HF-5G-LP-SS	\$2586	170

Gas Table w/ Enclosed Base



PHF-5G-NAT/LP-BS

Units are shown with spillage pans, spillage pans are sold separately.

Natural Gas Model #	LP Gas Model #	List Price	Wgt.
HF-2G-NAT-BS	HF-2G-LP-BS	\$2425	117
HF-3G-NAT-BS	HF-3G-LP-BS	\$2824	145
HF-4G-NAT-BS	HF-4G-LP-BS	\$3312	187
HF-5G-NAT-BS	HF-5G-LP-BS	\$3838	205

Gas tables with stainless steel liners in each well

Natural Gas Model #	LP Gas Model #	List Price	Wgt.
HF-2G-NAT-BS-SS	HF-2G-LP-BS-SS	\$2515	117
HF-3G-NAT-BS-SS	HF-3G-LP-BS-SS	\$2954	145
HF-4G-NAT-BS-SS	HF-4G-LP-BS-SS	\$3493	187
HF-5G-NAT-BS-SS	HF-5G-LP-BS-SS	\$4061	205

Gas Table w/ Enclosed Base & Doors



PHF-5G-NAT/LP-DR

Units are shown with spillage pans, spillage pans are sold separately.

Natural Gas Model #	LP Gas Model #	List Price	Wgt.
HF-2G-NAT-DR	HF-2G-LP-DR	\$2954	127
HF-3G-NAT-DR	HF-3G-LP-DR	\$3309	155
HF-4G-NAT-DR	HF-4G-LP-DR	\$4044	197
HF-5G-NAT-DR	HF-5G-LP-DR	\$4745	215

Gas tables with stainless steel liners in each well

Natural Gas Model #	LP Gas Model #	List Price	Wgt.
HF-2G-NAT-DR-SS	HF-2G-LP-DR-SS	\$3044	127
HF-3G-NAT-DR-SS	HF-3G-LP-DR-SS	\$3443	155
HF-4G-NAT-DR-SS	HF-4G-LP-DR-SS	\$4225	197
HF-5G-NAT-DR-SS	HF-5G-LP-DR-SS	\$4970	215

Toll Free : 800-645-2526 Call Today!



HOT FOOD TABLES

Wetbath Tables

FEATURES:

- 15,000 BTU'S / 2 and 3 compartments
- 25,000 BTU'S / 4 and 5 compartments
- Single control knob with 3 settings
- Pilot indicator openings
- Dish shelf of stainless steel
- Stainless steel undershelf
- Stainless steel lining
- 1" thick poly cutting board (8" wide)
- "NAT" is natural gas, "LP" is bottled gas
- For Safety Pilot add **\$341** list per well and the prefix "SP" to the model number
- For portable units add **\$292** list and prefix "P" to the model number (LP Gas models only).
- 5" swivel casters, with two brakes on portable units
- Universal mount push handle (right/left), on portable units

Wet Gas units are perfect for prepared food. It maintains food temperature with hot steam. Add 1-2" of water to the wet bath unit to achieve the correct amount of hot moisture.

Length of Units:	
2 Well	31 13/16"
3 Well	47 1/8"
4 Well	62 3/8"
5 Well	77 3/4"



Note: Units are not designed to cook or heat frozen or refrigerated foods. Food placed in tables should already be hot, and the table will maintain the proper temperatures.

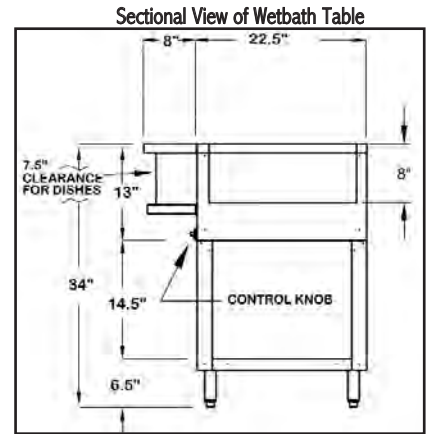

Wetbath Tables



WB-4G-NAT/LP
Dish Shelf supplied with Wet Bath only.
Dish shelf is sold separately on page 16.

Natural Gas Model #	LP Gas Model #	List Price	Wgt.
WB-2G-NAT	WB-2G-LP	\$1513	95
WB-3G-NAT	WB-3G-LP	\$1710	124
WB-4G-NAT	WB-4G-LP	\$2001	157
WB-5G-NAT	WB-5G-LP	\$2325	176

Wetbath w/ Enclosed Base



WB-5G-NAT/LP-BS
Units are shown with spillage pans, spillage pans are sold separately.

Natural Gas Model #	LP Gas Model #	List Price	Wgt.
WB-2G-NAT-BS	WB-2G-LP-BS	\$2605	120
WB-3G-NAT-BS	WB-3G-LP-BS	\$2930	148
WB-4G-NAT-BS	WB-4G-LP-BS	\$3349	192
WB-5G-NAT-BS	WB-5G-LP-BS	\$3803	211

Drop-in Sealed Well Unit



HOT FOOD TABLES

FEATURES:

- Unit to be hard wired in the field to control panel
- Infinite switch
- Indicator lights
- Single phase wiring
- Fiberglass insulation between each compartment
- Drains with gate valves per well

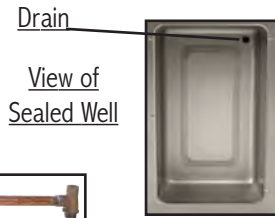

Outside Dimensions:

1 Well	.25" x 17"
2 Well	.25" x 32 5/16"
3 Well	.25" x 47 5/8"
4 Well	.25" x 62 15/16"
5 Well	.25" x 78 1/4"
6 Well	.25" x 93 9/16"

Thermostatic Controls - add the suffix **-T** to the model number and add additional pricing per the chart below.

Manifold Drains - add the suffix **-M** to the model number and add additional pricing per the chart below.

Thermostatic Controls & Manifold Drains - add the suffix **-MT** to the model number and add additional pricing per the chart below.

# Wells	1	2	3	4	5	6
List Price	96	194	289	386	481	580

# Wells	1	2	3	4	5	6
List Price	N/A	161	224	321	418	512

# Wells	1	2	3	4	5	6
List Price	N/A	355	513	707	899	1092



All drop-ins feature 12 x 20 die stamped openings. Full stainless steel construction inside and out. Remote control panel with infinite controls. Units are supplied with drains for wet or dry application.

Wells	120V Model #	Amps/Watts	208V Model #	Amps/Watts	240V Model #	Amps/Watts	Cut-out Size (Unit)	Cut-out Size (Controls)	List Price	Wgt.
1	DISW-1-120	20/1100	DISW-1-208	20/825	DISW-1-240	20/1100	22-7/8" x 15-1/8"	4-5/16" x 7-3/8"	\$1223	34
2	DISW-2-120	20/1100	DISW-2-208	20/825	DISW-2-240	20/1100	22-7/8" x 30-7/16"	4-5/16" x 15-3/8"	\$1509	46
3	DISW-3-120	50/1100	DISW-3-208	20/825	DISW-3-240	20/1100	22-7/8" x 45-3/4"	4-5/16" x 15-3/8"	\$1793	58
4			DISW-4-208	30/825	DISW-4-240	30/1100	22-7/8" x 61-1/8"	4-5/16" x 15-3/8"	\$2438	70
5			DISW-5-208	30/825	DISW-5-240	30/1100	22-7/8" x 76-3/8"	4-5/16" x 15-3/8"	\$3050	82
6			DISW-6-208	50/825	DISW-6-240	50/1100	22-7/8" x 91-11/16" (2ea)	4-5/16" x 15-3/8"	\$3692	94

Drop-in Cold Pan Unit

FEATURES:

Drop-in Cold pan units can be placed in existing countertops and other work areas to house items that need to be kept ice cooled. Perfect for cold bar items such as bottle drinks or salad bar items.

Cold pan units have a 1" dia. drain and are foam in place insulated.

Outside Dimensions:

1 Well	.25" x 17"
2 Well	.25" x 32 5/16"
3 Well	.25" x 47 5/8"
4 Well	.25" x 62 15/16"
5 Well	.25" x 78 1/4"
6 Well	.25" x 93 9/16"



Wells	Model #	Cut-out Size	List Price	Wgt.
1	DICP-1	22-7/8" x 15-1/8"	\$1029	29
2	DICP-2	22-7/8" x 30-7/16"	\$1223	41
3	DICP-3	22-7/8" x 45-3/4"	\$1413	53
4	DICP-4	22-7/8" x 61-1/8"	\$1736	65
5	DICP-5	22-7/8" x 76-3/8"	\$1993	77
6	DICP-6	22-7/8" x 91-11/16"	\$2250	89

Toll Free : 800-645-2526 Call Today!



HOT FOOD TABLES

Cold Pan Tables

FEATURES:

These multi-purpose units can be used to ice down cold items, such as fruit, pudding, yogurt, other desserts, and drinks. They can also be used for a salad bar.

- For portable units add \$292 list and prefix "P" to the model number.

Length of Units:	
2 Well	31 13/16"
3 Well	47 1/8"
4 Well	62 3/8"
5 Well	77 3/4"



CPU-3



Model #	List Price	Wgt.
CPU-2	\$1073	90
CPU-3	\$1299	118
CPU-4	\$1513	150
CPU-5	\$1764	168

Models w/ Enclosed Bases

Model #	List Price	Wgt.
CPU-2-BS	\$2166	115
CPU-3-BS	\$2520	143
CPU-4-BS	\$2861	185
CPU-5-BS	\$3243	203

Models w/ Enclosed Bases & Doors

Model #	List Price	Wgt.
CPU-2-DR	\$2713	125
CPU-3-DR	\$3132	153
CPU-4-DR	\$3537	195
CPU-5-DR	\$3981	213

Solid Top Tables

FEATURES:

These units are designed to be used to showcase fine foods, dessert displays, or as beverage stands.

- For portable units add \$292 list and prefix "P" to the model number.

Length of Units:	
2 Well	31 13/16"
3 Well	47 1/8"
4 Well	62 3/8"
5 Well	77 3/4"



STU-3



Model #	List Price	Wgt.
STU-2	\$ 812	90
STU-3	\$ 991	118
STU-4	\$1155	150
STU-5	\$1421	168

Models w/ Enclosed Bases

Model #	List Price	Wgt.
STU-2-BS	\$1905	115
STU-3-BS	\$2211	143
STU-4-BS	\$2504	185
STU-5-BS	\$2900	203

Models w/ Enclosed Bases & Doors

Model #	List Price	Wgt.
STU-2-DR	\$2450	125
STU-3-DR	\$2821	153
STU-4-DR	\$3178	195
STU-5-DR	\$3638	213

Hot Food Accessories



HOT FOOD TABLES

FEATURES:

- Shelves are 18 gauge
- Serving and buffet shelf brackets are fabricated from 16 gauge stainless steel K.D. construction
- Sneezeguards are made of Lexan® for strength and durability
- All hardware is included
- Simple assembly is required



TOS-3-18



STOS-3

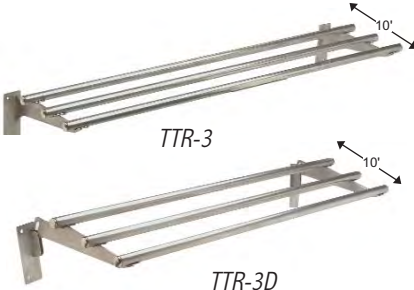

TTR-3

TTR-3D

Tray Rails-Stationary & Drop-Down

Model	List Price	Ship Weight	Cu.Ft.
Stationary			
TTR-2	\$ 412	12	3
TTR-3	\$ 458	14	4
TTR-4	\$ 537	16	5
TTR-5	\$ 667	19	6
Drop-Down			
TTR-2D	\$ 594	14	3
TTR-3D	\$ 614	16	4
TTR-4D	\$ 704	18	5
TTR-5D	\$ 828	21	6

Double Overshelf

Model	List Price	Ship Weight	Cu.Ft.
12" wide			
TOS-2	\$ 1053	32	3
TOS-3	\$ 1157	38	4
TOS-4	\$ 1325	44	5
TOS-5	\$ 1527	49	6
18" wide			
TOS-2-18	\$ 1159	35	3
TOS-3-18	\$ 1272	41	4
TOS-4-18	\$ 1450	47	5
TOS-5-18	\$ 1678	53	6

Single Overshelf

Model	List Price	Ship Weight	Cu.Ft.
12" wide			
STOS-2	\$ 528	18	3
STOS-3	\$ 576	21	4
STOS-4	\$ 650	24	5
STOS-5	\$ 763	27	6
18" wide			
STOS-2-18	\$ 579	20	3
STOS-3-18	\$ 638	23	4
STOS-4-18	\$ 715	26	5
STOS-5-18	\$ 841	30	6



TBS-3



TSS-3

Buffet Shelf

Model	List Price	Ship Weight	Cu.Ft.
TBS-2	\$ 944	28	3
TBS-3	\$ 978	33	4
TBS-4	\$ 1126	38	5
TBS-5	\$ 1313	45	6

Serving Shelf

Model	List Price	Ship Weight	Cu.Ft.
TSS-2	\$ 463	17	3
TSS-3	\$ 506	20	4
TSS-4	\$ 573	23	5
TSS-5	\$ 642	27	6



TTS-3

Solid Tray Shelf

Model	List Price	Ship Weight	Cu.Ft.
TTS-2	\$ 345	15	3
TTS-3	\$ 384	17	4
TTS-4	\$ 458	19	5
TTS-5	\$ 573	21	6



TDS-3

Cutting board not supplied with Dish-Shelf add on.

Dish-Shelf Add On

Model	List Price	Ship Weight	Cu.Ft.
TDS-2	\$ 143	15	3
TDS-3	\$ 167	17	4
TDS-4	\$ 212	19	5
TDS-5	\$ 225	21	6



TCB-3

Cutting Board Add On

Model	List Price	Ship Weight	Cu.Ft.
TCB-2	\$ 110	15	3
TCB-3	\$ 154	17	4
TCB-4	\$ 206	19	5
TCB-5	\$ 233	21	6

Spillage Pans

Used for HOT FOOD/STEAM (GAS OR ELECTRIC)
12.750" x 20.750" x 6.250"



Model	List Price	Weight
SP-A ALUMINUM	\$ 78	7
SP-S STAINLESS	\$ 143	7

Toll Free : 800-645-2526 Call Today!



HOT FOOD TABLES

Parts & Warranty Info

Warranty Info

SupremeMetal, Inc. Limited Warranty (FOR GAS AND ELECTRIC UNITS ONLY)

SupremeMetal Inc. warrants that all units manufactured will be free from defects at the time of shipment. Warranty is valid for 1 year from the date of installation or no more than 2 years from date of shipment. This warranty applies to manufactured or component parts. Contact the SupremeMetal Customer Service Department for a listing of authorized service agencies. SupremeMetal Inc. is not responsible for damage, or business loss of any kind resulting from defective unit or installation of replacement unit.

TERMS AND CONDITIONS OF WARRANTY

1. To original user only. Bill of Sale must be submitted with all claims.
2. Claims must be made to manufacturer within 30 days of discovery of defect.
3. Manufacturer may provide service by authorized agency for 90 days after installation of unit free of charge.
4. Defective units, if necessary, will be freight prepaid by shipper for inspection.
5. Replacement units, if necessary will be freight prepaid by manufacturer.

6. This warranty may be rescinded by manufacturer without prior notice.
7. Any claim under this warranty must be made in writing to SupremeMetal, Inc.

WARRANTY VOID IF:

1. Unit has been transferred from the original user.
2. Unit is serviced by person other than an authorized agency, or not in compliance with local code.
3. Unit is altered or modified in any way.
4. Unit has any accessory parts affixed which are not recommended or installed by manufacturer.
5. Unit is installed outside the continental United States.

Triumph Line Parts

Model	Description	Net Price
9000	Gas control knob	\$ 5.00
9001	Gas regulator-LP	\$ 10.00
9002	Gas regulator-NAT	\$ 10.00
9003	Gas valve	\$ 16.00
9020	HF-jet burner / orifice-LP	\$ 23.00
9021	HF-jet burner / orifice-NAT	\$ 23.00
9022	HF-pilot assembly	\$ 9.00
9035	WB-2 & 3 well orifice-LP	\$ 8.00
9036	WB-2 & 3 well orifice-NAT	\$ 8.00
9037	WB-4 & 5 well orifice-LP	\$ 8.00
9038	WB-4 & 5 well orifice-NAT	\$ 8.00
9054	HF-element-120 volt	\$ 23.00
9056	HF-element 208/240 volt	\$ 23.00
9044	SW-element 120 volt	\$ 23.00
9045	SW/DISW-element 208/240 volt	\$ 23.00
9046	DISW-element 120 volt	\$ 23.00

Model	Description	Net Price
9039	WB-pilot	\$ 20.00
9040	WB-pilot valve	\$ 8.00
9050	Electrical control knob	\$ 5.00
9051	Cord set w/ plug 5-20P	\$ 17.00
9062	Cord set w/ plug 6-20P	\$ 17.00
9052	Cord set w/ plug L5-30P	\$ 44.00
9053	Cord set w/ plug L6-30P	\$ 44.00
9055	Infinite switch 120 volt	\$ 19.00
9058	Infinite switch 208/240 volt	\$ 19.00
9059	Indicator light - 120 volt	\$ 8.00
9060	Indicator light - 208/240 volt	\$ 8.00
9071	Portable handle only	\$ 19.00
9072	3 phase wiring	\$ 79.00
9073	1000 WATT element per well (HF Only)	\$ 35.00
9070	Portable kit	\$146.00
9074	High limit switch	\$ 20.00

Electric Unit Plug Information



NEMA PLUG 5-20P

- HF-2E-120
- HF-3E-120
- B2-120
- B3-120
- SW-2E-120
- SW-3E-120



NEMA PLUG 6-20P

- HF-2E-208 B2-208
- HF-3E-208 B3-208
- HF-4E-208 B4-208
- HF-2E-240 B2-240
- HF-3E-240 B3-240
- SW-2E-208
- SW-3E-208
- SW-2E-240
- SW-3E-240



NEMA PLUG L5-30P

- HF-4E-120
- SW-4E-120
- B4-120



NEMA PLUG L6-30P

- HF-5E-208 B5-208
- HF-4E-240 B5-240
- HF-5E-240 B4-240
- SW-4E-208
- SW-5E-208
- SW-4E-240
- SW-5E-240

Modular Bar Die System

Prestige

FEATURES:

- Die Wall can be sealed to the floor, eliminating moisture in the bar structure.
- Recessed equipment outlets, permitting equipment to sit flush against the bar die wall.
- GFI outlets set in place and ready to be wired by on-site electrician meeting local codes.
- Stainless Steel panels supplied where equipment by others is located.
- Complete steel construction will not rot.
- Precise engineering to ensure an exact fit.
- Enclosed casing for beer towers.
- Soda gun outlets supplied where specified.
- Cantilever system eliminates the need for legs, simplifying cleanup!
- Predefined space for plumbing and drain lines supplied in bar die structure.



Modular Bar Die offers the customer the option of installing a cantilever system, utilizing the Prestige series of quality underbar. Each section of Prestige equipment is attached to the bar die wall eliminating the need for legs. All of the electrical, plumbing and soda lines are installed out of sight in the bar die wall.

The bar is assembled and divided into sections for shipment. The crated sections will arrive on the job site ready for installation. Simply set the sections in place, level, then secure the sections together and attach to the floor. It's that simple. Imagine the installation, labor costs and time you will save.

The structure on the bartender's side is completely fabricated of stainless steel. The actual bar die is fabricated of heavy gauge galvanized steel with cutouts for plumbing and beer lines. Junction boxes are located on each section.

Once the bar die is installed, the millwork can be set in place. The outside panels, located in a channel under the bar top, slide out. The panels attach at the bottom using simple clips on the provided vertical hat channels. If there is ever a plumbing or electrical problem, access to the frame is a snap!

1) Uncrate and set into place.



2) Bolt together with self tapping screws.



3) Level with shims.



4) Secure to floor.



5) Silicone seams.



6) Install plumbing, electrical and soda lines.



These are just some of the Modular Bar Die projects completed!

- TGIFridays
- Buckhead Mountain Grill
- Tumbleweeds
- Stix
- Texas Roadhouse
- Appalachian Grille
- UCF Rosen School
- Boulevard, Bowery
- D'Lite Sports Bar
- Bistro on Vine
- Shoreline Brewery
- California Dreaming

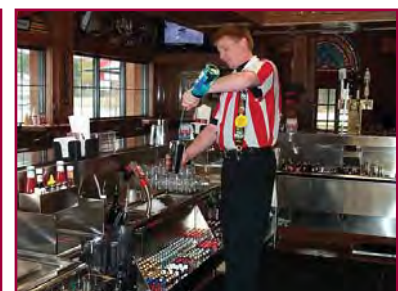

Model #	Description	Price
PR-BARDIE	Charge calculated per linear foot (12")	Consult factory for pricing

Flat Panel Section
With Recessed Outlet



Ice Bin Section



Cabinet Section

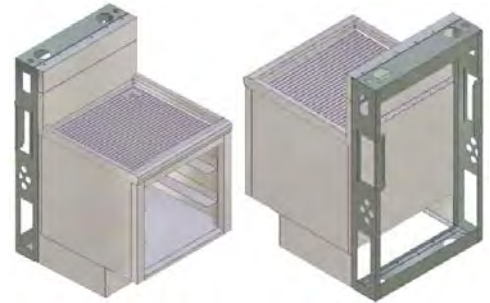

- Structure: 16 gauge galvanized steel equipment support structure. 20 gauge series #302 stainless steel interior on the bartender's side.

- Standard Prestige equipment attaches directly to the bar die structure. The equipment is available in 19" & 24" series.

- Electrical junction boxes are included in each section of the bar sections. This will be determined by the pre-fabrication layout drawings that are provided on every job.

Sectional View

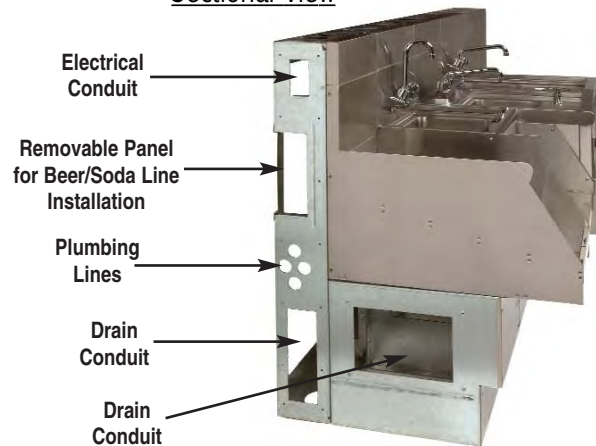

Millwork Assembly Suggestions (not supplied by SupremeMetal)

Shown here are some examples of Millwork styles that can be used. These pieces can be attached directly to the bar structure or simple clips can be attached to the front panel that slide onto a horizontal anchor.

These pieces can be pre-fabricated and installed immediately after the bar installation is complete. The look of the bar is now beautifully coordinated with the decor.



Bar Top and Drink rail can be fabricated from equipment drawings ahead of time.

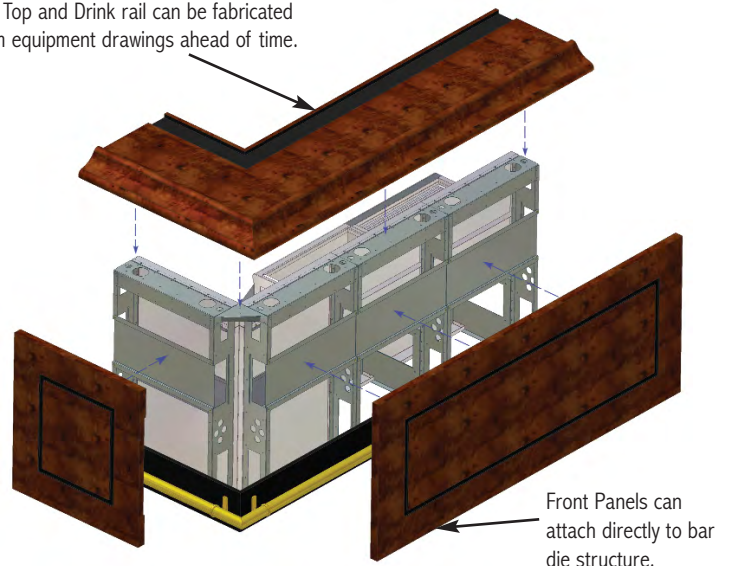

SupremeMetal leads the way with a quality driven line of underbar products. We will leave our competition behind with our superior craftsmanship.

The basic engineering of our Prestige line is easily explained. This series comes in two widths, 19" series and the 24" series. The difference between the two is 5", in width which is equal to either a rear deck or a single speed rail. There are certain pieces that do not allow for a speed rail. These units already have the extra 5" included. The units that already include the extra 5" in the front are marked throughout the *Prestige* section of this price list with an asterisk (*) next to the model number.

For example:

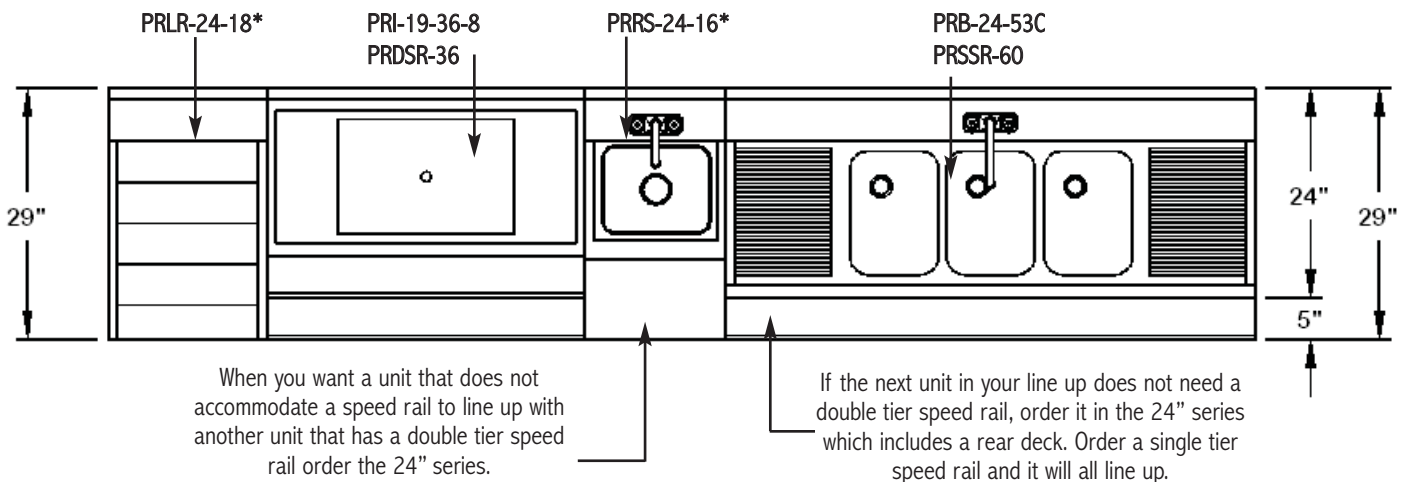
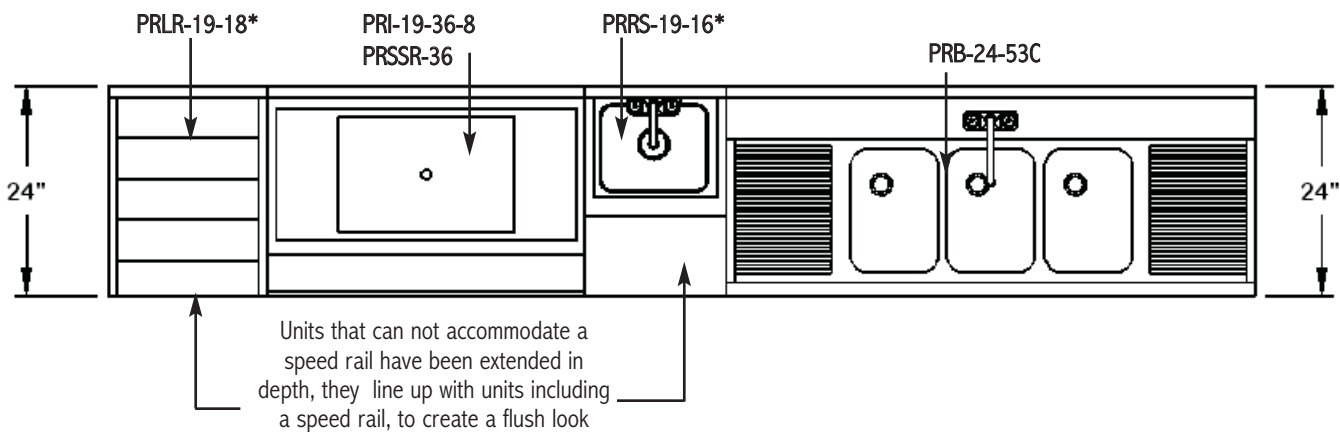

Refer to spec sheets for more detailed information.

Prestige

Prestige Bar Sinks

The Prestige series is constructed for heavy duty use, yet it maintains an appealing look. The bar sinks are constructed from stainless steel from top to bottom.

FEATURES:

Standard Features Include:

- 10 x 14 x 10 sink bowls with 1 1/2" I.P.S. drains
- Overflow pipes are included for each sink bowl
- Continuous ribbed corrugation on drainboard sections
- All units are undercoated for sound deadening.
- Mirror finish 18 gauge molding
- 7" high backsplash
- Stainless steel drains
- Heavy Duty faucets included



PRB-24-64C



PRB-19-53C



	19" Series					24" Series				
	Size	Model #	List	Wgt.	Cu.Ft.	Size	Model #	List	Wgt.	Cu.Ft.
1 Compartment	3'	PRB-19-31C	\$1358	79	11	3'	PRB-24-31C	\$1434	89	13
2 Compartment	2'	PRB-19-22C	\$1363	79	11	2'	PRB-24-22C	\$1403	89	13
	3'	PRB-19-32L	\$1466	79	11	3'	PRB-24-32L	\$1526	89	13
	3'	PRB-19-32R	\$1466	79	11	3'	PRB-24-32R	\$1526	89	13
	4'	PRB-19-42C	\$1540	92	14	4'	PRB-24-42C	\$1622	105	17
	4'	PRB-19-42L	\$1540	92	14	4'	PRB-24-42L	\$1622	105	17
3 Compartment	4'	PRB-19-42R	\$1540	92	14	4'	PRB-24-42R	\$1622	105	17
	3'	PRB-19-33C	\$1801	92	14	3'	PRB-24-33C	\$1861	105	17
	4'	PRB-19-43L	\$2108	94	14	4'	PRB-24-43L	\$2185	107	17
	4'	PRB-19-43R	\$2108	94	14	4'	PRB-24-43R	\$2185	107	17
	5'	PRB-19-53C	\$2293	109	18	5'	PRB-24-53C	\$2369	125	22
	5'	PRB-19-53L	\$2293	109	18	5'	PRB-24-53L	\$2369	125	22
	5'	PRB-19-53R	\$2293	109	18	5'	PRB-24-53R	\$2369	125	22
4 Compartment	6'	PRB-19-63C	\$2411	125	21	6'	PRB-24-63C	\$2506	143	26
	7'	PRB-19-73C	\$2508	139	25	7'	PRB-24-73C	\$2606	159	30
	8'	PRB-19-83C	\$2628	153	28	8'	PRB-24-83C	\$2755	176	34
	4'	PRB-19-44C	\$2248	94	14	4'	PRB-24-44C	\$2327	107	17
	6'	PRB-19-64C	\$2748	125	21	6'	PRB-24-64C	\$2842	147	26
	7'	PRB-19-74C	\$2850	143	25	7'	PRB-24-74C	\$2963	163	30
	8'	PRB-19-84C	\$2958	157	28	8'	PRB-24-84C	\$3087	178	34

Bar Sink Accessories

Misc. Bar Sink Accessories

A-16	perforated basket.....	\$186
A-15	chrome towel ring.....	\$ 37
A-1	perforated cover for sink bowl.....	\$ 55
A-2	2 compartment waste assembly.....	\$ 49
A-3	3 compartment waste assembly.....	\$ 59
A-4	4 compartment waste assembly.....	\$ 73

Side Splashes

PRA-19-SS-L	Side splash left for 19" unit.....	\$ 106
PRA-19-SS-R	Side splash right for 19" unit.....	\$ 106
PRA-24-SS-L	Side splash left for 24" unit.....	\$ 110
PRA-24-SS-R	Side splash right for 24" unit.....	\$ 110

Wrist Handles (upgrade for heavy duty faucets)

A-85	wrist handles upgrade for deck mount faucet	\$ 78
A-86	wrist handles upgrade for splash mount faucet	\$ 78

Prestige Ice Bins

Prestige



PRI-19-24
W/ PRSSR-24

Prestige Ice bins without cold plates are constructed out of stainless steel from top to bottom.

Standard features: mirrored front molding, foam insulation, black polyethylene thermal breaker marine edge, and 2ea. 3-pak bottle storage racks. Units are supplied with 1" I.P.S. drains. The legs are heavy gauge stainless steel with 1-5/8" O.D. and stainless steel bullet feet.

On the 24" series we have removed the rear deck and made the ice bin larger for more ice capacity.



PRC-19-48LR

19" Series						24" Series					
Ice Bin Size	Model #	List	Wgt.	Ice Capacity	Cu.Ft.	Ice Bin Size	Model #	List	Wgt.	Ice Capacity	Cu.Ft.
12"	PRI-19-12	\$706	40	32	6	12"	PRI-24-12	\$738	45	42	6
24"	PRI-19-24	\$1087	65	70	9	24"	PRI-24-24	\$1127	70	93	11
30"	PRI-19-30	\$1179	70	89	13	30"	PRI-24-30	\$1222	75	118	16
36"	PRI-19-36	\$1282	75	108	13	36"	PRI-24-36	\$1332	80	143	16
42"	PRI-19-42	\$1505	80	127	14	42"	PRI-24-42	\$1631	85	168	17
48"	PRI-19-48	\$1576	85	146	14	48"	PRI-24-48	\$1766	90	194	17
Extra Deep Ice Bins											
24"	PRI-19-24-XD	\$1451	80	80	13	24"	PRI-24-24-XD	\$1490	85	106	15
30"	PRI-19-30-XD	\$1541	85	121	14	30"	PRI-24-30-XD	\$1587	90	161	16
36"	PRI-19-36-XD	\$1645	90	147	16	36"	PRI-24-36-XD	\$1695	95	195	19
Combo Ice Bins											
36"	PRC-19-36L	\$1778	90	70/32	12	36"	PRC-24-36L	\$1846	105	93/42	15
36"	PRC-19-36R	\$1778	90	70/32	12	36"	PRC-24-36R	\$1846	105	93/42	15
42"	PRC-19-42L	\$1905	105	89/32	14	42"	PRC-24-42L	\$1988	110	118/42	17
42"	PRC-19-42R	\$1905	105	89/32	14	42"	PRC-24-42R	\$1988	110	42/118	17
48"	PRC-19-48L	\$2033	115	108/32	16	48"	PRC-24-48L	\$2132	120	143/42	19
48"	PRC-19-48R	\$2033	115	108/32	16	48"	PRC-24-48R	\$2132	120	42/143	19
48"	PRC-19-48LR	\$2500	145	32/70/32	16	48"	PRC-24-48LR	\$2605	160	42/93/42	16
54"	PRC-19-54LR	\$2592	150	32/89/32	18	54"	PRC-24-54LR	\$2698	165	42/118/42	18
60"	PRC-19-60LR	\$2695	155	32/108/32	20	60"	PRC-24-60LR	\$2807	170	42/143/42	20
Pass-Thru Ice Bin											
42"	PRPT-2442	\$1834	80	174	13						



Ice Bin Accessories for 19" Series

Stainless Steel Sliding Covers

PRA-SSC-12	..Fits 12" ice bin	..\$84
PRA-SSC-18	..Fits 18" ice bin	..\$91
PRA-SSC-24	..Fits 24" ice bin	..\$98
PRA-SSC-30	..Fits 30" ice bin	..\$104
PRA-SSC-36	..Fits 36" ice bin	..\$110
PRA-SSC-42	..Fits 42" ice bin	..\$117
PRA-SSC-48	..Fits 48" ice bin	..\$123
PRA-SSC-PT	..Fits Pass thru bin	..\$149

Blender Shelf Add-on

PRA-BS-12	..12" Blender shelf	..\$191
PRA-BS-16	..16" Blender shelf	..\$199
PRA-BS-18	..18" Blender shelf	..\$206
PRA-BS-24	..24" Blender shelf	..\$235
PRA-BS-30	..30" Blender shelf	..\$243

Bottle Wells

PRA-BR-3	...3 bottle wells\$88
PRA-BR-6	...6 bottle wells\$113

Condiment / Cover / Bottle Wells For 24" models

PRA-2403	..3 bottle wells & cover\$180
PRA-2404	..6 bottle wells & cover\$261
PRA-2405	..5 condiment cups\$199
PRA-2406	..6 bottle wells/3 cond. cups\$297

Condiment / Cover / Bottle Wells For 30" models

PRA-3003	..3 bottle wells & cover\$186
PRA-3004	..6 bottle wells & cover\$268
PRA-3005	..6 condiment cups\$227
PRA-3006	..6 bottle wells/4 cond. cups\$337

Condiment / Cover / Bottle Wells For 36" models

PRA-3603	..3 bottle wells & cover\$192
PRA-3604	..6 bottle wells & cover\$274
PRA-3605	..7 condiment cups\$241
PRA-3606	..6 bottle wells/5 cond. cups\$376

Condiment / Cover / Bottle Wells For 42" models

PRA-4203	..3 bottle wells & cover\$198
PRA-4204	..6 bottle wells & cover\$280
PRA-4205	..8 condiment cups\$317
PRA-4206	..6 bottle wells/6 cond. cups\$417

Condiment / Cover / Bottle Wells For 48" models

PRA-4803	..3 bottle wells & cover\$205
PRA-4804	..6 bottle wells & cover\$294
PRA-4805	..9 condiment cups\$358
PRA-4806	..6 bottle wells/7 cond. cups\$455

Condiment / Cover / Bottle Wells For Pass Thru

PRA-2424	..3 bottle wells & cover\$180
PRA-2425	..6 bottle wells & cover\$261
PRA-2426	..5 condiment cups\$206
PRA-2427	..6 bottle wells/3 cond. cups\$303



Bottle Well & Sliding Cover

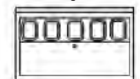

Condiment Cup Configuration



Bottle Well & Condiment Cup

Toll Free : 800-645-2526 Call Today!

Prestige Ice bins with 8 circuit cold plates are stainless steel construction top to bottom. All units offer as standard features: mirrored front molding, foam insulation, black polyethylene thermal breaker marine edge, and 2ea. 3-pak bottle storage racks.

These units are supplied with stainless steel 1/2" I.P.S. drains that are located in the cold plate. The legs are heavy gauge stainless steel with 1-5/8" O.D. and stainless bullet feet.

A combination unit consists of a large bin ranging in size from 24", 30", & 36" and a smaller ice bin that is always 12" wide. The R or L denote which side the large ice bin is located. The smaller ice chest can be used to ice down wine or specialty chilled products. This ensures the bartender clean ice for drinks.



PRI-24-24

19" Series						24" Series					
Size	Model #	List	Wgt.	Ice Capacity	Cu.Ft.	Size	Model #	List	Wgt.	Ice Capacity	Cu.Ft.
24"	PRI-19-24-8	\$2436	135	70	9	24"	PRI-24-24-8	\$2477	140	93	11
30"	PRI-19-30-8	\$2529	140	89	13	30"	PRI-24-30-8	\$2570	145	118	16
36"	PRI-19-36-8	\$2630	145	108	13	36"	PRI-24-36-8	\$2680	150	143	16
42"	PRI-19-42-8	\$2854	150	127	14	42"	PRI-24-42-8	\$2980	155	168	17
48"	PRI-19-48-8	\$2925	155	146	14	48"	PRI-24-48-8	\$3117	160	194	17
Extra Deep Ice Bins with 8 Circuit Cold Plates											
24"	PRI-19-24-8-XD	\$2800	160	80	13	24"	PRI-24-24-8-XD	\$2839	165	106	15
30"	PRI-19-30-8-XD	\$2891	165	121	14	30"	PRI-24-30-8-XD	\$2937	170	161	16
36"	PRI-19-36-8-XD	\$2993	170	147	15	36"	PRI-24-36-8-XD	\$3046	175	195	19
Combo Ice Bins with 8 Circuit Cold Plates											
36"	PRC-19-36L-8	\$3126	160	70/32	12	36"	PRC-24-36L-8	\$3196	165	93/42	15
36"	PRC-19-36R-8	\$3126	160	70/32	12	36"	PRC-24-36R-8	\$3196	165	93/42	15
42"	PRC-19-42L-8	\$3354	170	89/32	14	42"	PRC-24-42L-8	\$3337	175	118/42	17
42"	PRC-19-42R-8	\$3354	170	89/32	14	42"	PRC-24-42R-8	\$3337	175	42/118	17
48"	PRC-19-48L-8	\$3383	180	108/32	16	48"	PRC-24-48L-8	\$3480	185	143/42	19
48"	PRC-19-48R-8	\$3383	180	108/32	16	48"	PRC-24-48R-8	\$3480	185	42/143	19
48"	PRC-19-48LR-8	\$3850	180	32/70/32	16	48"	PRC-24-48LR-8	\$3954	195	42/93/42	19
54"	PRC-19-54LR-8	\$3942	185	32/89/32	16	54"	PRC-24-54LR-8	\$4048	200	42/118/42	19
60"	PRC-19-60LR-8	\$4044	190	32/108/32	20	60"	PRC-24-60LR-8	\$4158	205	42/143/42	20
Pass-Thru Ice Bin with 8 Circuit Cold Plate											
42"	PRPT-2442-8	\$3187	150	174	13						



Ice Bin Accessories for 24" Series

Stainless Steel Sliding Covers

PRA-SSCD-12	..Fits 12" ice bin ..	\$102
PRA-SSCD-18	..Fits 18" ice bin ..	\$110
PRA-SSCD-24	..Fits 24" ice bin ..	\$117
PRA-SSCD-30	..Fits 30" ice bin ..	\$125
PRA-SSCD-36	..Fits 36" ice bin ..	\$131
PRA-SSCD-42	..Fits 42" ice bin ..	\$140
PRA-SSCD-48	..Fits 48" ice bin ..	\$148

Glass Shelves-Hangs on backplash

PRA-GS-12	...12" Glass shelf ...	\$115
PRA-GS-18	...18" Glass shelf ...	\$125
PRA-GS-24	...24" Glass shelf ...	\$135
PRA-GS-30	...30" Glass shelf ...	\$144
PRA-GS-36	...36" Glass shelf ...	\$154
PRA-GS-48	...48" Glass shelf ...	\$183

Condiment / Cover / Bottle Wells For 24" models

PRA-2403D	..4 bottle wells & cover	\$227
PRA-2404D	..8 bottle wells & cover	\$337
PRA-2405	..5 condiment cups	\$199
PRA-2406D	..8 bottle wells/3 cond. cups ..	\$356

Condiment / Cover / Bottle Wells For 30" models

PRA-3003D	..4 bottle wells & cover	\$235
PRA-3004D	..8 bottle wells & cover	\$346
PRA-3005	..6 condiment cups	\$227
PRA-3006D	..8 bottle wells/4 cond. cups ..	\$396

Condiment / Cover / Bottle Wells For 36" models

PRA-3603D	..4 bottle wells & cover	\$242
PRA-3604D	..8 bottle wells & cover	\$352
PRA-3605	..7 condiment cups	\$241
PRA-3606D	..8 bottle wells/5 cond. cups ..	\$435

Condiment / Cover / Bottle Wells For 42" models

PRA-4203D	..4 bottle wells & cover	\$250
PRA-4204D	..8 bottle wells & cover	\$360
PRA-4205	..8 condiment cups	\$317
PRA-4206D	..8 bottle wells/6 cond. cups ..	\$473

Condiment / Cover / Bottle Wells For 48" models

PRA-4803D	..4 bottle wells & cover	\$259
PRA-4804D	..8 bottle wells & cover	\$368
PRA-4805	..9 condiment cups	\$358
PRA-4806D	..8 bottle wells/7 cond. cups ..	\$514

Bottle Wells

PRA-BR-4	...4 bottle wells ...	\$118
PRA-BR-8	...8 bottle wells ...	\$157



Prestige Pass Thru Station

Prestige



Pre-priced pass-thru service stations include pass thru ice bins, single or double sided sink, tubing chase for soda gun, blender station and speed rail on bartender's side.

Option for stainless steel side panels.

PR-46X42SP-8-R with PRSO-44 shown.

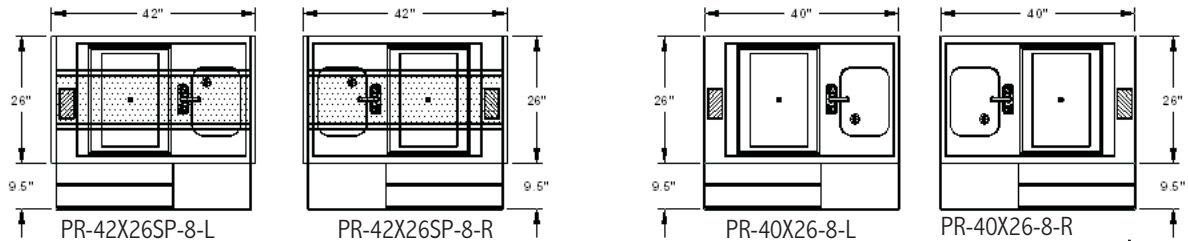

Model #	Description	List	Wgt.	Ice Capacity	Cubic Feet
PR-40X26-8-R	Pass thru ice bin with 8 circuit cold plate,	\$4171	200	70	15
PR-40X26-8-L	10" x 14" x 10" sink with heavy duty faucet and tubing chase.				
PR-42X26SP-8-R	Pass thru ice bin with 8 circuit cold plate, 10" x 14" x 10" sink w/ Heavy Duty faucet	\$5889	315	70	46
PR-42X26SP-8-L	and tubing chase-stainless steel side panels and shelf with perforated top.				

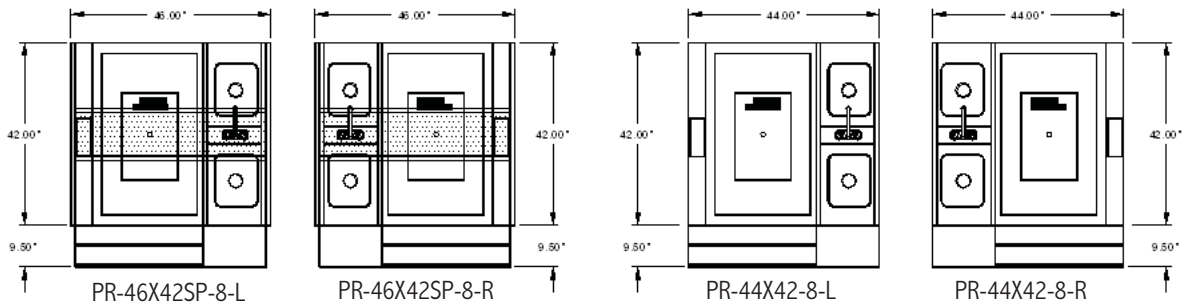

Model #	Description	List	Wgt.	Ice Capacity	Cubic Feet
PR-44X42-8-R	Pass thru ice bin with 8 circuit cold plate,	\$6917	300	174	30
PR-44X42-8-L	two hand sinks with one faucet and a tubing chase				
PR-46X42SP-8-R	Pass thru ice bin with 8 circuit cold plate,	\$8281	450	174	73
PR-46X42SP-8-L	two hand sinks with one faucet, tubing chase, stainless steel side panels and shelf with perforated top.				

Over Shelf

Stainless over shelves. Choose from single overshelf, double overshelf or double overshelf with stemware glass rack.



Size	Model #	Description	List	Wgt.	Cu.Ft.
15" x 40"	PRSO-40	single overshelf (for small station)	\$ 676	60	4
15" x 40"	PRDO-40	double overshelf (for small station)	\$1350	120	16
15" x 40"	PRDO-40-G	double overshelf w/ stemware glass rack	\$1718	140	16
15" x 44"	PRSO-44	single overshelf (for large station)	\$ 736	65	5
15" x 44"	PRDO-44	double overshelf (for large station)	\$1473	125	17
15" x 44"	PRDO-44-G	double overshelf w/ stemware glass rack	\$1841	145	17

Toll Free : 800-645-2526 Call Today!

Portable Ice Bin



Not supplied with cross-braced legs as shown

Portable ice bin with an extra deep lining (15") for bottle beer storage. Supplied with 6" stainless steel legs and 4" casters to go where the volume is. Each unit has a drain with shut off valve.

Size	Model #	Description	List	Wgt.	Cu.Ft.
24"	PRI-MIC-24	19" x 24" Extra Deep Portable Ice bin	\$1411	80	13
30"	PRI-MIC-30	19" x 30" Extra Deep Portable Ice bin	\$1473	85	14
36"	PRI-MIC-36	19" x 36" Extra Deep Portable Ice bin	\$1571	90	16

Frozen Drink Machine Stand



The Frozen Drink Machine Stand has a lower working height to accommodate the height of most drink machines for use under the bar. Each unit has a beveled front and a drain in the center rear of the unit. Please verify your drink machine size before ordering.

Size	Model #	Description	List	Wgt.	Cu.Ft.
18"	PRFD-18	will hold one drink machine	\$799	45	10
30"	PRFD-30	will hold two drink machines	\$1350	180	18

Trash Receptacle



To help keep the bar area sparkling clean, a 12" trash receptacle can be specified into any line-up. Unit is supplied with stainless steel sliding cover. Unit will accept trash receptacle that measures 11" x 20" x 25" tall (15-7/8 gallons). No legs supplied, unit attaches to equipment on either side.

Size	Model #	Description	List	Wgt.	Cu.Ft.
12"	PRT-12	trash receptacle	\$560	35	4

Prestige Uni-Servs

Prestige

Prestige Uni-Serv cocktail stations are fully constructed from stainless steel. They consist of a 30" ice bin which is designated by either a **L** for left side, or **R** for right side in the model number. In the center is a blender recess station/dump sink, and on the other end a recessed glass shelf is supplied. All units come standard with a 30" speed rail, and 2ea. 3-pak bottle storage racks.

These units are supplied with stainless steel 1" I.P.S. drains and the legs are heavy gauge stainless steel with 1-5/8" O.D.



PRU-19-60L

19" Series

Uni-Servs Without Cold Plates

Size	Model #	List	Wgt.	Ice Capacity	Cu.Ft.
60"	PRU-19-60L *	\$3407	130	89	23
60"	PRU-19-60R *	\$3407	130	89	23

Uni-Servs With 8 Circuit Cold Plates

Size	Model #	List	Wgt.	Ice Capacity	Cu.Ft.
60"	PRU-19-60L-8 *	\$4757	165	89	23
60"	PRU-19-60R-8 *	\$4757	165	89	23

24" Series

Size	Model #	List	Wgt.	Cu.Ft.
60"	PRU-24-60L *	\$3451	135	26
60"	PRU-24-60R *	\$3451	135	26

Size	Model #	List	Wgt.	Cu.Ft.
60"	PRU-24-60L-8 *	\$4801	170	26
60"	PRU-24-60R-8 *	\$4801	170	26

For * info see page 20

Ice Cream Unit

New from SupremeMetal Inc. A cabinet to house a refrigerated ice cream unit.

- Supplied with dipperwell faucet
- Factory cut out sized to specified dimensions
- Heavy gauge stainless steel legs – 1 5/8" O.D.



Size	Model #	Description	List	Wgt.	Cu.Ft.
30"	PR-IC-30-L	30" with dipperwell on left, must supply the ice cream unit's cut-out size	\$1963	70	12
30"	PR-IC-30-R	30" with dipperwell on right, must supply the ice cream unit's cut-out size	\$1963	70	12
42"	PR-IC-42-L	42" with dipperwell on left, must supply the ice cream unit's cut-out size	\$2331	90	16
42"	PR-IC-42-R	42" with dipperwell on right, must supply the ice cream unit's cut-out size	\$2331	90	16

Toll Free : 800-645-2526 Call Today!

All service units supplied with blender shelf and hidden duplex outlet. Each unit is undercoated to deaden the sound of clinking glasses and liquor bottles. These service units cannot accommodate a speedrail, the 19" series is actually 24" front to back and the 24" series is 29" front to back. This will allow these units to line up with standard units and speedrails to achieve a *flush* look.

19" Series

24" Series

Size	Model #	List	Wgt.	Cu.Ft.	Size	Model #	List	Wgt.	Cu.Ft.
12"	PRRS-19-12 *	\$1107	28	4	12"	PRRS-24-12 *	\$1179	28	4
16"	PRRS-19-16 *	\$1119	30	4	16"	PRRS-24-16 *	\$1192	30	4
12"	PRWW-19-12 *	\$1038	28	4	12"	PRWW-24-12 *	\$1117	28	4
16"	PRWW-19-16 *	\$1050	30	4	16"	PRWW-24-16 *	\$1129	30	4
12"	PRDB-19-12 *	\$603	28	4	12"	PRDB-24-12 *	\$684	28	4
16"	PRDB-19-16 *	\$615	30	4	16"	PRDB-24-16 *	\$696	30	4



For * info see page 20

Features:

- Heavy duty faucets
- All stainless steel
- 15 amp-120 volt duplex outlet



PRRS-19-16



PRWW-19-16



PRDB-24-16

Hand Sinks

Three different styles of hand sink are available. All have a 9 1/2" x 11 1/2" x 6" stainless sink bowl. All hand sinks are available in 19" and 24" depths. The soap & towel model has a built in 'C' fold paper towel dispenser and a soap pump located by the sink bowl.

19" Series

24" Series

Size	Model #	List	Wgt.	Cu.Ft.	Size	Model #	List	Wgt.	Cu.Ft.
12"	PRHS-19-12	\$926	28	4	12"	PRHS-24-12	\$965	33	6
16"	PRHS-19-16	\$938	30	4	16"	PRHS-24-16	\$979	35	6
12"	PRHSST-19-12	\$1227	53	4	12"	PRHSST-24-12	\$1266	58	6
16"	PRHSST-19-16	\$1240	55	4	16"	PRHSST-24-16	\$1278	60	6
12"	PRHSC-19-12	\$1551	78	9	12"	PRHSC-24-12	\$1590	83	10
16"	PRHSC-19-16	\$1563	80	9	16"	PRHSC-24-16	\$1602	85	10

The cabinet base hand sink is supplied with a hinged door. This extra storage space can be used for just about anything.

Features:

- Heavy duty faucets
- All stainless steel



PRHS19-16



PRHSST-24-16



PRHSC-19-16



Prestige Drainboards

Prestige

FEATURES:

- Continuous ribbed corrugation
- 1" I.P.S. drains in back right corner
- Deep pitch for better drainage



The drainboard units come in a variety of sizes to suit every bar layout. They are constructed entirely of stainless steel and are undercoated to diminish sound.



PRD-19-24



PRBD19-24

Drainboards

19" Series					24" Series				
Size	Model #	List	Wgt.	Cu.Ft.	Size	Model #	List	Wgt.	Cu.Ft.
12"	PRD-19-12	\$540	38	4	12"	PRD-24-12	\$573	45	4
18"	PRD-19-18	\$598	45	7	18"	PRD-24-18	\$633	52	7
24"	PRD-19-24	\$660	52	8	24"	PRD-24-24	\$686	59	10
30"	PRD-19-30	\$713	59	11	30"	PRD-24-30	\$753	66	10
36"	PRD-19-36	\$756	65	11	36"	PRD-24-36	\$804	73	13
42"	PRD-19-42	\$827	70	11	42"	PRD-24-42	\$882	79	14
48"	PRD-19-48	\$949	75	15	48"	PRD-24-48	\$1019	86	17
Beer Drainer w/ 3" x 6" rear column for beer lines									
18"	PRBD-19-18	\$720	50	7	18"	PRBD-24-18	\$756	57	7
24"	PRBD-19-24	\$782	57	8	24"	PRBD-24-24	\$808	64	10



PRSCD-19-48

Storage Cabinets come with or without doors. These units have the same features as the drainboards, but are made with sturdy cabinet bases. To add a stationary mid shelf, add the suffix *-M* after the model number and add the correct list price below to determine the complete cost.

- | | |
|------------------|------------------|
| 18" unit = \$54 | 24" unit = \$68 |
| 30" unit = \$81 | 36" unit = \$91 |
| 42" unit = \$105 | 48" unit = \$117 |

Drainboard Cabinets with Doors

19" Series					24" Series				
Size	Model #	List	Wgt.	Cu.Ft.	Size	Model #	List	Wgt.	Cu.Ft.
18"	PRSCD-19-18 *	\$1112	65	12	18"	PRSCD-24-18 *	\$1210	72	15
24"	PRSCD-19-24 *	\$1261	72	12	24"	PRSCD-24-24 *	\$1349	79	15
30"	PRSCD-19-30 *	\$1400	79	15	30"	PRSCD-24-30 *	\$1500	85	18
36"	PRSCD-19-36 *	\$1529	85	18	36"	PRSCD-24-36 *	\$1638	92	22
42"	PRSCD-19-42 *	\$1686	90	21	42"	PRSCD-24-42 *	\$1802	98	28
48"	PRSCD-19-48 *	\$1894	95	24	48"	PRSCD-24-48 *	\$2025	102	30

Drainboard Cabinets without Doors

19" Series					24" Series				
Size	Model #	List	Wgt.	Cu.Ft.	Size	Model #	List	Wgt.	Cu.Ft.
18"	PRSCO-19-18 *	\$906	55	12	18"	PRSCO-24-18 *	\$1001	62	15
24"	PRSCO-19-24 *	\$1028	62	12	24"	PRSCO-24-24 *	\$1116	69	15
30"	PRSCO-19-30 *	\$1141	69	15	30"	PRSCO-24-30 *	\$1244	76	18
36"	PRSCO-19-36 *	\$1247	75	18	36"	PRSCO-24-36 *	\$1355	82	22
42"	PRSCO-19-42 *	\$1380	80	21	42"	PRSCO-24-42 *	\$1495	90	28
48"	PRSCO-19-48 *	\$1562	85	24	48"	PRSCO-24-48 *	\$1693	92	30

For * info see page 20

Toll Free : 800-645-2526 Call Today!



PRCR-19-24
(ACCESSORIES NOT INCLUDED)



PROR-24-24
(ACCESSORIES NOT INCLUDED)



PRSR-19-24
(ACCESSORIES NOT INCLUDED)

19" Series

Size	Model #	List	Wgt.	Cu.Ft.
24"	PRCR-19-24 *	\$1179	45	12
24"	PROR-19-24 *	\$996	50	12
24"	PRSR-19-24 *	\$1137	50	12

24" Series

Size	Model #	List	Wgt.	Cu.Ft.
24"	PRCR-24-24 *	\$1250	52	12
24"	PROR-24-24 *	\$1065	57	12
24"	PRSR-24-24 *	\$1208	57	12

For * info see page 20

Recess Glass Shelf

Each Recess Glass Shelf offers continuous corrugation, and a pitch for easy draining. It has a 1" I.P.S. drain that is located in the upper right hand corner. The side uprights are constructed of 14 gauge stainless steel for extra durability.



PRGS-19-24



19" Series

Size	Model #	List	Wgt.	Cu.Ft.
12"	PRGS-19-12 *	\$409	40	4
18"	PRGS-19-18 *	\$436	45	7
24"	PRGS-19-24 *	\$462	52	7
30"	PRGS-19-30 *	\$488	59	11

24" Series

Size	Model #	List	Wgt.	Cu.Ft.
12"	PRGS-24-12 *	\$444	45	6
18"	PRGS-24-18 *	\$481	52	9
24"	PRGS-24-24 *	\$508	59	9
30"	PRGS-24-30 *	\$534	66	13

For * info see page 20

Prestige Liquor Storage

Prestige



PRLR-19-24



PRLR-19-24-LC

Liquor storage racks are undercoated to deaden sound. This unit will store and display all of your fine liquors within easy reach.

To add a locking cover add the suffix **-LC** after the model number and add the correct list price below to determine the complete cost.

12" unit = \$419

18" unit = \$444

24" unit = \$470

30" unit = \$495

36" unit = \$522

19" Series					24" Series				
Size	Model #	List	Wgt.	Cu.Ft.	Size	Model #	List	Wgt.	Cu.Ft.
12"	PRLR-19-12 *	\$853	25	4	12"	PRLR-24-12 *	\$881	30	5
18"	PRLR-19-18 *	\$996	30	6	18"	PRLR-24-18 *	\$1030	35	8
24"	PRLR-19-24 *	\$1137	35	8	24"	PRLR-24-24 *	\$1180	40	10
30"	PRLR-19-30 *	\$1278	40	10	30"	PRLR-24-30 *	\$1330	45	12
36"	PRLR-19-36 *	\$1421	50	12	36"	PRLR-24-36 *	\$1477	55	15

For * info see page 20

Wet / Dry Waste Cabinet



PRWC-19-36

Wet/Dry Waste Cabinets come standard without doors. Unit has dual functions; hand sink (9.5" x 11.5" x 6") with heavy duty faucet in the rear for liquid waste, and a dry waste (5" diameter) chute in the front. Available with open base or hinged doors.



For * info see page 20

19" Series					24" Series				
Size	Model #	List	Wgt.	Cu.Ft.	Size	Model #	List	Wgt.	Cu.Ft.
18"	PRWC-19-18 *	\$1619	55	12	18"	PRWC-24-18 *	\$1653	62	15
24"	PRWC-19-24 *	\$1959	62	12	24"	PRWC-24-24 *	\$2003	69	15
30"	PRWC-19-30 *	\$2300	69	15	30"	PRWC-24-30 *	\$2352	76	18
36"	PRWC-19-36 *	\$2430	75	18	36"	PRWC-24-36 *	\$2478	82	22
42"	PRWC-19-42 *	\$2493	78	18	42"	PRWC-24-42 *	\$2546	84	22
48"	PRWC-19-48 *	\$2557	85	24	48"	PRWC-24-48 *	\$2612	92	30
Wet / Dry Waste Cabinet with doors									
18"	PRWC-19-18-DR *	\$1828	60	12	18"	PRWC-24-18-DR *	\$1863	65	15
24"	PRWC-19-24-DR *	\$2192	67	12	24"	PRWC-24-24-DR *	\$2235	72	15
30"	PRWC-19-30-DR *	\$2558	74	15	30"	PRWC-24-30-DR *	\$2609	79	18
36"	PRWC-19-36-DR *	\$2712	80	18	36"	PRWC-24-36-DR *	\$2760	85	22
42"	PRWC-19-42-DR *	\$2800	86	22	42"	PRWC-24-42-DR *	\$2852	91	22
48"	PRWC-19-48-DR *	\$2889	90	24	48"	PRWC-24-48-DR *	\$2944	95	30

Toll Free : 800-645-2526 Call Today!

Does your customer have a unique shaped bar? Do you have gaps in your layout in between equipment? Our full line of Prestige fillers will solve these problems. There are several different sizes offered to help you create a good workspace flow. The fillers are measured by the degree of the angle in the bar you are trying to fill. The 90° fillers are designed for 90° turns and corners in the bar layout. These are the only fillers supplied with a leg channel for additional support. Fillers are installed by mounting them to the adjacent pieces of equipment they fit between. All fillers are offered with a flat top and some models offer corrugated tops with a drain. For custom fillers please consult the factory for pricing and availability.

Front Fill-In Units

19" Series					24" Series				
Size	Model #	List	Wgt.	Cu.Ft.	Size	Model #	List	Wgt.	Cu.Ft.
30 °	PRF-19-30F	\$274	20	4	30 °	PRF-24-30F	\$295	22	4
45 °	PRF-19-45F	\$295	20	4	45 °	PRF-24-45F	\$328	22	4
60 °	PRF-19-60F	\$328	20	4	60 °	PRF-24-60F	\$357	22	4
90 °	PRF-19-90F	\$357	25	4	90 °	PRF-24-90F	\$387	27	4
45 °	PRF-CR-19-45F	\$777	20	4	45 °	PRF-CR-24-45F	\$855	22	4

Rear Fill-In Units									
Size	Model #	List	Wgt.	Cu.Ft.	Size	Model #	List	Wgt.	Cu.Ft.
30 °	PRF-19-30R	\$274	20	4	30 °	PRF-24-30R	\$295	22	4
45 °	PRF-19-45R	\$295	20	4	45 °	PRF-24-45R	\$328	22	4
60 °	PRF-19-60R	\$328	20	4	60 °	PRF-24-60R	\$357	22	4
90 °	PRF-19-90R	\$357	25	4	90 °	PRF-24-90R	\$387	27	4
45 °	PRF-CR-19-45R	\$777	20	4	45 °	PRF-CR-24-45R	\$855	22	4
90 °	PRF-CR-19-90R	\$855	25	4	90 °	PRF-CR-24-90R	\$933	27	4



Corner Fill-In Units

19" Series					24" Series				
Size	Model #	List	Wgt.	Cu.Ft.	Size	Model #	List	Wgt.	Cu.Ft.
90 °	PRF-19-90CR	\$467	30	8	90 °	PRF-24-90CR	\$497	32	8
90 °	PRF-19-90CF	\$467	30	8	90 °	PRF-24-90CF	\$497	32	8
90 °	PRF-CR-19-90CR	\$1010	35	8	90 °	PRF-CR-24-90CR	\$1088	37	8



Prestige Speed Rails

Prestige

FEATURES:

- All stainless steel construction
- Mirrored front
- Sound deadened
- Single tier size
- Double tier size
- Hang - On tier addition
- Variety of lengths



PRSSR-24



PRDSR-36

Single Tier Speed Rails

Size	Model #	List	Wgt.
12"	PRSSR-12	\$137	4
16"	PRSSR-16	\$143	5
18"	PRSSR-18	\$148	5
24"	PRSSR-24	\$159	6
30"	PRSSR-30	\$170	7
36"	PRSSR-36	\$181	7
42"	PRSSR-42	\$192	8
48"	PRSSR-48	\$201	8
54"	PRSSR-54	\$214	9
60"	PRSSR-60	\$225	10
72"	PRSSR-72	\$246	12
84"	PRSSR-84	\$267	14
96"	PRSSR-96	\$289	16

Single Tier w/ Locking Covers

Size	Model #	List	Wgt.
12"	PRSSR-12-LC	\$305	8
16"	PRSSR-16-LC	\$341	10
18"	PRSSR-18-LC	\$379	10
24"	PRSSR-24-LC	\$420	12
30"	PRSSR-30-LC	\$461	14
36"	PRSSR-36-LC	\$502	14
42"	PRSSR-42-LC	\$544	16
48"	PRSSR-48-LC	\$585	16



PRSSR-24-LC



Hang - On Speed Rails

Size	Model #	List	Wgt.
12"	PRHSR-12	\$151	4
16"	PRHSR-16	\$156	4
18"	PRHSR-18	\$163	4
24"	PRHSR-24	\$175	5
30"	PRHSR-30	\$185	6
36"	PRHSR-36	\$199	6
42"	PRHSR-42	\$209	7
48"	PRHSR-48	\$223	7

Double Tier Speed Rails

Size	Model #	List	Wgt.
12"	PRDSR-12	\$215	8
16"	PRDSR-16	\$222	10
18"	PRDSR-18	\$268	10
24"	PRDSR-24	\$316	12
30"	PRDSR-30	\$366	14
36"	PRDSR-36	\$409	14
42"	PRDSR-42	\$459	16
48"	PRDSR-48	\$508	16
54"	PRDSR-54	\$557	18
60"	PRDSR-60	\$603	20
72"	PRDSR-72	\$699	24
84"	PRDSR-84	\$795	28
96"	PRDSR-96	\$881	32

Locking Double Tier

Model #	List	Wgt.
PRDSR-12-LC	\$466	16
PRDSR-16-LC	\$520	20
PRDSR-18-LC	\$614	22
PRDSR-24-LC	\$706	24
PRDSR-30-LC	\$803	28
PRDSR-36-LC	\$889	30
PRDSR-42-LC	\$988	32
PRDSR-48-LC	\$1084	34



PRHSR-30

Toll Free : 800-645-2526 Call Today!

Model #	Description	List	Wgt.
Tubing Chase			
PRA-19-TC	Tubing chase for 19" unit	\$158	10
PRA-24-TC	Tubing chase for 24" unit	\$171	10
Tip-Out in backsplash for soda lines			
PRA-TIP-OUT	4" wide tip out in backsplash	\$184	n/a
Side Splash			
PRA-19-SS-L	Side splash left for 19" unit	\$106	2
PRA-19-SS-R	Side splash right for 19" unit	\$106	2
PRA-24-SS-L	Side splash left for 24" unit	\$110	2
PRA-24-SS-R	Side splash right for 24" unit	\$110	2
Leg Shelves			
PRA-LS-12	12" leg shelf	\$47	5
PRA-LS-18	18" leg shelf	\$59	6
PRA-LS-24	24" leg shelf	\$69	8
PRA-LS-30	30" leg shelf	\$79	9
PRA-LS-36	36" leg shelf	\$87	11
PRA-LS-42	42" leg shelf	\$101	12
PRA-LS-48	48" leg shelf	\$110	14
PRA-LS-60	60" leg shelf	\$135	17
Blender Shelves- mounted on front apron of unit			
PRA-BS-12	12" blender shelf	\$191	12
PRA-BS-16	16" blender shelf	\$199	16
PRA-BS-18	18" blender shelf	\$206	18
PRA-BS-24	24" blender shelf	\$235	28
PRA-BS-30	30" blender shelf	\$243	36
Glass Shelves- hangs on backsplash of unit			
PRA-GS-12	12" glass shelf	\$115	6
PRA-GS-18	18" glass shelf	\$125	7
PRA-GS-24	24" glass shelf	\$135	9
PRA-GS-30	30" glass shelf	\$144	11
PRA-GS-36	36" glass shelf	\$154	13
PRA-GS-48	48" glass shelf	\$183	15
Locks for Cabinets			
PRA-LOCK	lock w/ key for cabinet door	\$109	1



PRA-19-TC



PRA-LS-30



PRA-BS-24



PRA-GS-24

Ice Bin Accessories

19" Series

Bottle Wells

PRA-BR-3	3 bottle wells	\$88
PRA-BR-6	6 bottle wells	\$113

Condiment / Cover / Bottle Wells For 24" models

PRA-2403	3 bottle wells & cover	\$180
PRA-2404	6 bottle wells & cover	\$261
PRA-2405	5 condiment cups	\$199
PRA-2406	6 bottle wells/3 cond. cups	\$297

Condiment / Cover / Bottle Wells For 30" models

PRA-3003	3 bottle wells & cover	\$186
PRA-3004	6 bottle wells & cover	\$268
PRA-3005	6 condiment cups	\$227
PRA-3006	6 bottle wells/4 cond. cups	\$337

Condiment / Cover / Bottle Wells For 36" models

PRA-3603	3 bottle wells & cover	\$192
PRA-3604	6 bottle wells & cover	\$274
PRA-3605	7 condiment cups	\$241
PRA-3606	6 bottle wells/5 cond. cups	\$376

Condiment / Cover / Bottle Wells For 42" models

PRA-4203	3 bottle wells & cover	\$198
PRA-4204	6 bottle wells & cover	\$280
PRA-4205	8 condiment cups	\$317
PRA-4206	6 bottle wells/6 cond. cups	\$417

Condiment / Cover / Bottle Wells For 48" models

PRA-4803	3 bottle wells & cover	\$205
PRA-4804	6 bottle wells & cover	\$294
PRA-4805	9 condiment cups	\$358
PRA-4806	6 bottle wells/7 cond. cups	\$455

Condiment / Cover / Bottle Wells For Pass Thru

PRA-2424	3 bottle wells & cover	\$180
PRA-2425	6 bottle wells & cover	\$261
PRA-2426	5 condiment cups	\$206
PRA-2427	6 bottle wells/3 cond. cups	\$303

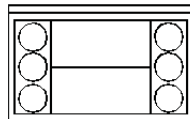

Bottle Well & Sliding Cover

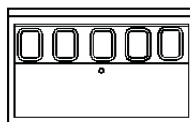

Condiment Cup Configuration

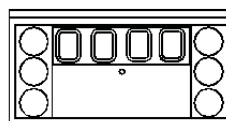

Bottle Well & Condiment Cup

24" Series

Bottle Wells

PRA-BR-4	4 bottle wells	\$118
PRA-BR-8	8 bottle wells	\$157

Condiment / Cover / Bottle Wells For 24" models

PRA-2403D	4 bottle wells & cover	\$227
PRA-2404D	8 bottle wells & cover	\$337
PRA-2405	5 condiment cups	\$199
PRA-2406D	8 bottle wells/3 cond. cups	\$356

Condiment / Cover / Bottle Wells For 30" models

PRA-3003D	4 bottle wells & cover	\$235
PRA-3004D	8 bottle wells & cover	\$346
PRA-3005	6 condiment cups	\$227
PRA-3006D	8 bottle wells/4 cond. cups	\$396

Condiment / Cover / Bottle Wells For 36" models

PRA-3603D	4 bottle wells & cover	\$242
PRA-3604D	8 bottle wells & cover	\$352
PRA-3605	7 condiment cups	\$241
PRA-3606D	8 bottle wells/5 cond. cups	\$435

Condiment / Cover / Bottle Wells For 42" models

PRA-4203D	4 bottle wells & cover	\$250
PRA-4204D	8 bottle wells & cover	\$360
PRA-4205	8 condiment cups	\$317
PRA-4206D	8 bottle wells/6 cond. cups	\$473

Condiment / Cover / Bottle Wells For 48" models

PRA-4803D	4 bottle wells & cover	\$259
PRA-4804D	8 bottle wells & cover	\$368
PRA-4805	9 condiment cups	\$358
PRA-4806D	8 bottle wells/7 cond. cups	\$514

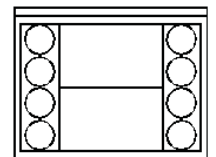

Bottle Well & Sliding Cover

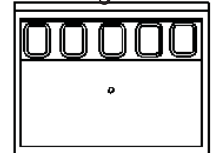

Condiment Cup Configuration

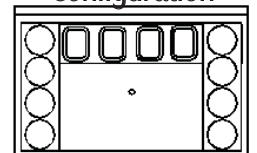

Bottle Well & Condiment Cup

See pages 22 & 23 for sliding Ice Bin Covers

Bar Sinks

*Slimline Series18"
Challenger Series...21"*

Slimline Features:

- 18" from front to back dimension
- 10 x 14 x 10 sink bowls
- 4" high backsplash
- Backsplash mounted faucet
- Black powder coated cross-braced legs
- Overflow pipes and stainless drains are included
- Actual overall lengths are 1" less than shown
- Molded apron for extra durability
- Stainless steel ends



SLB-53C



Challenger Features:

- 21" from front to back dimension
- 10 x 14 x 10 sink bowls
- 2³/₄" rear deck for extra storage
- 4" high backsplash
- Deck mount faucet
- Black powder coated cross-braced legs
- Overflow pipes and stainless drains are included
- Actual overall lengths are 1" less than shown
- Molded apron for extra durability
- Stainless steel ends

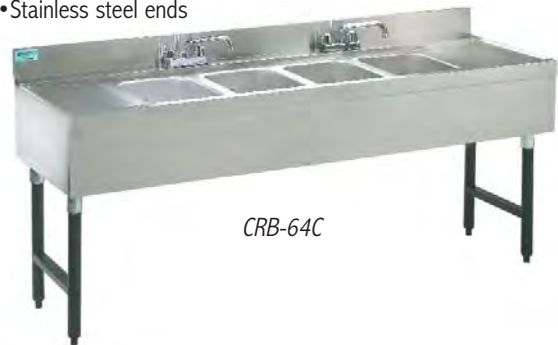

CRB-64C

Slimline (18")

Challenger (21")

	Unit Size	Drbd Size	Model #	List Price	Wgt. Lbs.	Cu. Ft.	Model #	List Price	Wgt. Lbs.	Cu. Ft.
1 Compartment	3'	12" ea	SLB-31C	\$1027	51	9.3	CRB-31C	\$1134	55	10.1
2 Compartment	2'	N/A	SLB-22C	\$1086	51	9.3	CRB-22C	\$1168	54	10.1
	3'	9"	SLB-32L	\$1152	54	9.3	CRB-32L	\$1229	57	10.1
	3'	9"	SLB-32R	\$1152	54	9.3	CRB-32R	\$1229	57	10.1
	4'	21"	SLB-42L	\$1190	63	12.2	CRB-42L	\$1277	66	13.3
	4'	21"	SLB-42R	\$1190	63	12.2	CRB-42R	\$1277	66	13.3
3 Compartment	4'	12" ea	SLB-42C	\$1190	63	12.2	CRB-42C	\$1277	66	13.3
	3'	N/A	SLB-33C	\$1245	62	9.3	CRB-33C	\$1332	65	10.1
	4'	9"	SLB-43L	\$1311	65	12.2	CRB-43L	\$1402	68	13.3
	4'	9"	SLB-43R	\$1311	65	12.2	CRB-43R	\$1402	68	13.3
	5'	21"	SLB-53L	\$1380	74	15.1	CRB-53L	\$1476	76	16.5
	5'	21"	SLB-53R	\$1380	74	15.1	CRB-53R	\$1476	76	16.5
	5'	12" ea	SLB-53C	\$1380	74	15.1	CRB-53C	\$1476	76	16.5
	6'	18" ea	SLB-63C	\$1454	82	18	CRB-63C	\$1556	88	19.7
	7'	24" ea	SLB-73C	\$1617	92	20.9	CRB-73C	\$1730	98	22.9
4 Compartment	8'	30" ea	SLB-83C	\$1769	103	23.8	CRB-83C	\$1898	108	26.1
	4'	N/A	SLB-44C	\$1545	85	12.2	CRB-44C	\$1648	89	13.3
	6'	12" ea	SLB-64C	\$1718	88	18	CRB-64C	\$1830	92	19.7
	7'	18" ea	SLB-74C	\$1828	94	20.9	CRB-74C	\$1956	101	22.9
	8'	24" ea	SLB-84C	\$1988	105	23.8	CRB-84C	\$1997	110	26.1

5-Year Limited Bowl Warranty will be added to each unit=\$6.00 LIST
See warranty page for the complete details of our Limited Bowl Warranty information.

To include stainless steel legs & bullet feet on any of the above units
add the suffix **-SS** to the model number and \$80 list.

Bar Sink Accessories

Misc. Bar Sink Accessories

A-16	perforated basket.....	\$186
A-15	chrome towel ring.....	\$37
A-1	perforated cover for sink bowl.....	\$58
A-2	2 compartment waste assembly.....	\$49
A-3	3 compartment waste assembly.....	\$59
A-4	4 compartment waste assembly.....	\$73

Side Splashes

Side Splash-L	Side splash left	\$110
Side Splash-R	Side splash right	\$110

Wrist Handle Upgrade for Standard Faucets

A-83	deck mount faucet upgrade.....	\$68
A-84	splash mount faucet upgrade.....	\$68

Slimline Features:

- 18" from front to back dimension
- 10 x 14 x 10 sink bowls
- 4" high backsplash
- Splash mount faucet
- All ice compartments are 8" deep
- Black powder coated cross-braced legs
- Overflow pipes and stainless drains are included
- Actual overall lengths are 1" less than shown
- Molded apron for extra durability
- Stainless steel ends

Challenger Features:

- 21" from front to back dimension
- 10 x 14 x 10 sink bowls
- 2 3/4" rear deck for extra storage
- 4" high backsplash
- Deck mount faucet
- All ice compartments are 8" deep
- Black powder coated cross-braced legs
- Overflow pipes and stainless drains are included
- Actual overall lengths are 1" less than shown
- Molded apron for extra durability
- Stainless steel ends



Slimline (18")

Challenger (21")

	Unit Size	Model #	List Price	Wgt. Lbs.	Cu. Ft.		Model #	List Price	Wgt. Lbs.	Cu. Ft.
3 Compartment w/ 24" ice bin	7'	SLC-73C-L	\$2092	108	20.9		CRC-73C-L	\$2236	115	23
	7'	SLC-73C-R	\$2092	108	20.9		CRC-73C-R	\$2236	115	23
	8'	SLC-83C-L	\$2168	118	23.8		CRC-83C-L	\$2313	126	26
	8'	SLC-83C-R	\$2168	118	23.8		CRC-83C-R	\$2313	126	26
4 Compartment w/ 24" ice bin	8'	SLC-84C-L	\$2430	120	23.8		CRC-84C-L	\$2590	129	26
	8'	SLC-84C-R	\$2430	120	23.8		CRC-84C-R	\$2590	129	26

The R & L in the model # denotes which side the ice bin is located.



SLC-73C-R



CRC-83C-L

To include stainless steel legs & bullet feet on any of the above units add the suffix **-SS** to the model number and \$80 list.

Slimline Features:

- 18" from front to back dimension
- 1" I.P.S. drains
- 4" high backsplash
- 3-Pak Bottle Racks (2) Removable (A-20)
- Black powder coated cross-braced legs



Challenger Features:

- 21" from front to back dimension
- 1" I.P.S. drains
- 2 3/4" rear deck for extra storage
- 4" high backsplash
- 3-Pak Bottle Racks (2) Removable (A-20)
- Black powder coated cross-braced legs

Description	Unit Size	Model #	Slimline (18")				Challenger (21")				
			List Price	Wgt. Lbs.	Ice Capacity	Cu. Ft.	Model #	List Price	Wgt. Lbs.	Ice Capacity	Cu. Ft.
<i>8" deep cocktail units</i>	15"	SLJ-15	\$682	40	30	6	CRJ-15	\$731	48	30	6
	23"	SLJ-24	\$715	48	54	7	CRJ-24	\$757	53	54	7.2
	35"	SLJ-36	\$887	62	83	9.3	CRJ-36	\$932	66	83	10.1
<i>12" deep ice bins</i>	12"	SLI-12-12	\$689	26	35	6	CRI-12-12	\$751	28	35	6
	23"	SLI-12-24	\$873	52	77	7	CRI-12-24	\$932	61	77	8
	29"	SLI-12-30	\$964	60	98	11	CRI-12-30	\$1031	67	98	11
	35"	SLI-12-36	\$1054	68	119	12.6	CRI-12-36	\$1130	74	119	12.6
	41"	SLI-12-42	\$1103	72	140	12.8	CRI-12-42	\$1177	78	140	13
	47"	SLI-12-48	\$1153	80	161	13.5	CRI-12-48	\$1228	86	161	13.9
<i>16" deep ice bins</i>	23"	SLI-16-24	\$1117	61	100	7	CRI-16-24	\$1201	68	100	8
	29"	SLI-16-30	\$1245	69	127	11.5	CRI-16-30	\$1336	76	127	12
	35"	SLI-16-36	\$1373	77	155	15.5	CRI-16-36	\$1471	84	155	17
<i>Combo ice bins</i>	35"	SLCI-36L	\$1562	73	77/35	11	CRCI-36L	\$1683	82	77/35	12.6
	35"	SLCI-36R	\$1562	73	35/77	11	CRCI-36R	\$1683	82	35/77	12.6
	41"	SLCI-42L	\$1653	81	98/35	12	CRCI-42L	\$1781	89	98/35	13
	41"	SLCI-42R	\$1653	81	35/98	12	CRCI-42R	\$1781	89	35/98	13
	47"	SLCI-48L	\$1743	89	119/35	13	CRCI-48L	\$1879	95	119/35	13.9
	47"	SLCI-48R	\$1743	89	35/119	13	CRCI-48R	\$1879	95	35/119	13.9
	47"	SLCI-48LR	\$2251	104	35/77/35	14	CRCI-48LR	\$2432	113	35/77/35	15
	53"	SLCI-54LR	\$2343	112	35/98/35	14.5	CRCI-54LR	\$2530	119	35/98/35	15.5
59"	SLCI-60LR	\$2433	120	35/119/35	15	CRCI-60LR	\$2629	126	35/119/35	16.5	
<i>Pass - Thru ice bin</i>	See Challenger listing for 23" x 36" pass-thru unit						CRPT-2436	\$1840	80	210	13

To include stainless steel legs & bullet feet on any of the above units add the suffix -SS to the model number and \$80 list.



CRI-16-24



CRI-12-36
Kwik pours are not included.



CRCI-36L
Kwik pours are not included.

2 piece s/s sliding cover available for all units. See page 37 for pricing and ordering information.

**Bottle racks (A-20's) must be removed for NSF compliance and use with cover.



Toll Free : 800-645-2526 Call Today!

Slimline Features:

- 18" from front to back dimension
- 1/2" I.P.S. drain in 7 circuit post mix cold plate
- 4" high backsplash
- 3-Pak Bottle Racks (2) Removable (A-20)
- Black powder coated cross-braced legs



Challenger Features:

- 21" from front to back dimension
- 1/2" I.P.S. drain in 7 circuit post mix cold plate
- 2 3/4" rear deck for extra storage
- 4" high backsplash
- 3-Pak Bottle Racks (2) Removable (A-20)
- Black powder coated cross-braced legs

Description	<u>Slimline (18")</u>						<u>Challenger (21")</u>				
	Unit Size	Model #	List Price	Wgt. Lbs.	Ice Capacity	Cu. Ft.	Model #	List Price	Wgt. Lbs.	Ice Capacity	Cu. Ft.
8" deep cocktail units w/ 7 circuit cold plate	23"	SLJ-24-7	\$1819	82	54	6	CRJ-24-7	\$1862	87	54	7.2
	35"	SLJ-36-7	\$1990	94	83	9.3	CRJ-36-7	\$2036	102	83	10.1
12" deep ice bins w/ 7 circuit cold plate	23"	SLI-12-24-7	\$1977	88	77	7	CRI-12-24-7	\$2036	93	77	8
	29"	SLI-12-30-7	\$2069	92	98	11	CRI-12-30-7	\$2135	95	98	11
	35"	SLI-12-36-7	\$2158	98	119	12.6	CRI-12-36-7	\$2233	102	119	12.6
	41"	SLI-12-42-7	\$2206	105	140	12.8	CRI-12-42-7	\$2281	108	140	13
	47"	SLI-12-48-7	\$2256	110	161	13.5	CRI-12-48-7	\$2332	119	161	13.9
16" deep ice bins w/ 7 circuit cold plate	23"	SLI-16-24-7	\$2221	96	100	7	CRI-16-24-7	\$2306	103	100	8
	29"	SLI-16-30-7	\$2347	104	127	11.5	CRI-16-30-7	\$2441	115	127	12
	35"	SLI-16-36-7	\$2477	112	155	15.5	CRI-16-36-7	\$2575	120	155	17
Combo ice bins w/ 7 circuit cold plate	35"	SLCI-36L-7	\$2666	105	77/35	11	CRCI-36L-7	\$2786	114	77/35	12.6
	35"	SLCI-36R-7	\$2666	105	35/77	11	CRCI-36R-7	\$2786	114	35/77	12.6
	41"	SLCI-42L-7	\$2758	113	98/35	12	CRCI-42L-7	\$2885	121	98/35	13
	41"	SLCI-42R-7	\$2758	113	35/98	12	CRCI-42R-7	\$2885	121	35/98	13
	47"	SLCI-48L-7	\$2847	121	119/35	13	CRCI-48L-7	\$2983	127	119/35	13.9
	47"	SLCI-48R-7	\$2847	121	35/119	13	CRCI-48R-7	\$2983	127	35/119	13.9
	47"	SLCI-48LR-7	\$3355	136	35/77/35	14	CRCI-48LR-7	\$3537	145	35/77/35	15
	53"	SLCI-54LR-7	\$3448	144	35/98/35	14.5	CRCI-54LR-7	\$3633	151	35/98/35	15.5
	59"	SLCI-60LR-7	\$3538	152	35/119/35	15	CRCI-60LR-7	\$3734	158	35/119/35	16.5
Pass - Thru ice bin w/ 7 circuit cold plate	See Challenger listing for 23" x 36" pass-thru unit						CRPT-2436-7	\$2943	115	210	13

Ice Bin Accessories

A-8	condiment rack for backsplash.....	\$296	A-44	42" ice bin s/s false bottom	\$100
A-15	chrome towel ring.....	\$ 37	A-45	4' ice bin s/s false bottom.....	\$118
A-24	blender shelf with duplex outlet.....	\$114	SSC-12	for 12" ice bins.....	\$ 55
A-38	8" high partition to separate ice.....	\$ 51	SSC-15	for 15" ice bins.....	\$ 65
A-39	11" high partition to separate ice.....	\$ 51	SSC-23	for 24" ice bins.....	\$ 80
A-40	15" high partition to separate ice.....	\$ 51	SSC-29	for 30" ice bins.....	\$ 96
A-41	2' ice bin s/s false bottom	\$ 78	SSC-35	for 36" ice bins.....	\$106
A-42	30" ice bin s/s false bottom	\$ 85	SSC-47	for 48" ice bins.....	\$133
A-43	3' ice bin s/s false bottom	\$ 93	SSC-PT	for pass thru bin.....	\$123



SLI-16-36-7

To include stainless steel legs & bullet feet on any of the above units add the suffix -SS to the model number and \$80 list.

**Bottle racks (A-20's) must be removed for NSF compliance and use with cover.



CRPT-2436-7

Pass Thru Station

*Slimline Series18"
Challenger Series...21"*



CR-46X36SP-7-L

Pre-priced pass-thru service stations include pass thru ice bin, single or double sided sink, tubing chase for soda gun, blender station and speed rail on bartender's side.

Option for stainless steel side panels.

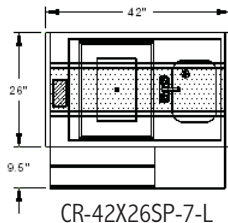

CR-42X26SP-7-L

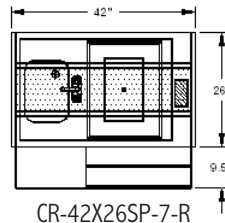

CR-42X26SP-7-R

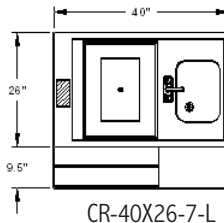

CR-40X26-7-L

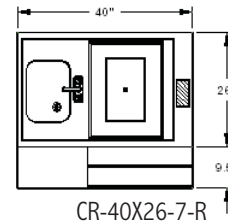

CR-40X26-7-R

Model #	Description	List	Weight	Ice Capacity	Cubic Feet
CR-40X26-7-L CR-40X26-7-R	Pass thru ice bin with 7 circuit cold plate, 10" x 14" x 10" sink with faucet and tubing chase.	\$3435	185	180	40
CR-42X26SP-7-L CR-42X26SP-7-R	Pass thru ice bin with 7 circuit cold plate, 10" x 14" x 10" sink w/ faucet and tubing chase-stainless steel side panels and shelf with perforated top.	\$4906	300	180	58

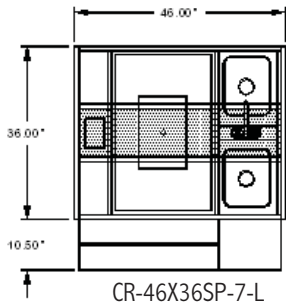

CR-46X36SP-7-L

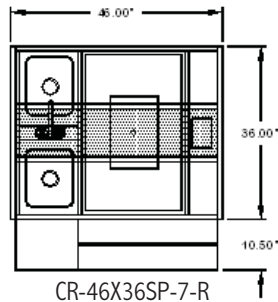

CR-46X36SP-7-R

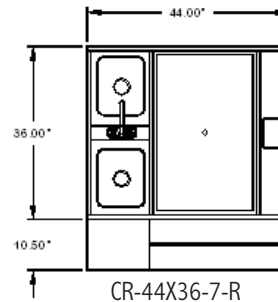

CR-44X36-7-R

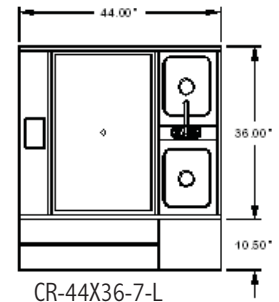

CR-44X36-7-L

Model #	Description	List	Weight	Ice Capacity	Cubic Feet
CR-44X36-7-L CR-44X36-7-R	Pass thru ice bin with 7 circuit cold plate, two hand sinks with one faucet and a tubing chase.	\$5152	285	210	45
CR-46X36SP-7-L CR-46X36SP-7-R	Pass thru ice bin with 7 circuit cold plate, two hand sinks with one faucet, tubing chase, stainless steel side panels and shelf with perforated top.	\$6624	425	210	68

Over Shelf

Stainless steel over shelves. Choose from single over shelf, double over shelf or double over shelf with stemware glass rack underneath top shelf.



Size	Model #	Description	List	Wgt.	Cu.Ft.
15" x 40"	SCSO-40	single over shelf	\$614	60	4
15" x 40"	SCDO-40	double over shelf	\$1227	120	16
15" x 40"	SCDO-40-G	double over shelf with stemware glass rack	\$1596	140	16
15" x 44"	SCSO-44	single over shelf	\$676	65	5
15" x 44"	SCDO-44	double over shelf	\$1289	125	17
15" x 44"	SCDO-44-G	double over shelf with stemware glass rack	\$1718	145	17

Toll Free : 800-645-2526 Call Today!

Features of the Uni-Serv Speed Bar:

- 30" (12" deep) ice bin w/ 2 ea (A-20's) bottle racks
- 6" deep dump sink
- Drop down glass storage
- Dual blender / mixer recess with duplex electrical outlet
- The R & L in the model number denotes ice bin location.



SLU-60R
Kwik pours are not included.

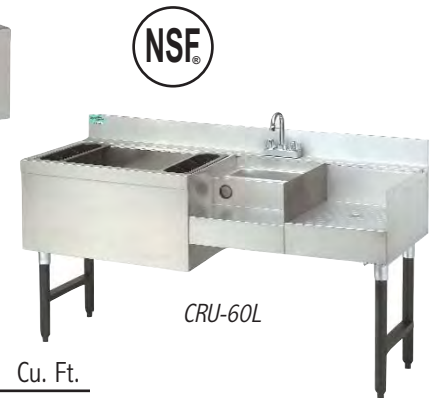

CRU-60L

Slimline (18")					Challenger (21")			
Unit Size	Model #	List Price	Wgt. Lbs.	Cu. Ft.	Model #	List Price	Wgt. Lbs.	Cu. Ft.
Uni-Serv								
5'	SLU-60R	\$2581	100	22	CRU-60R	\$2745	110	23
5'	SLU-60L	\$2581	100	22	CRU-60L	\$2745	110	23
Uni-Serv w/ 7 circuit post mix cold plate								
5'	SLU-60R-7	\$3683	135	22	CRU-60R-7	\$3849	145	23
5'	SLU-60L-7	\$3683	135	22	CRU-60L-7	\$3849	145	23

To include stainless steel legs & bullet feet on any of the above units add the suffix -SS to the model number and \$80 list.

Cocktail Workstations

Features:

- 23" (8" deep) ice bin w/ 2 ea (A-20's) bottle racks
- 24" drainboard section
- The R & L in the model number denotes ice bin location.



SLW-4L

Slimline (18")					Challenger (21")			
Unit Size	Model #	List Price	Wgt. Lbs.	Cu. Ft.	Model #	List Price	Wgt. Lbs.	Cu. Ft.
Uni-Serv								
47"	SLW-4R	\$1248	65	12.2	CRW-4R	\$1333	72	13.3
47"	SLW-4L	\$1248	65	12.2	CRW-4L	\$1333	72	13.3
Uni-Serv w/ 7 circuit post mix cold plate								
47"	SLW-4R-7	\$2353	100	12.2	CRW-4R-7	\$2436	108	13.3
47"	SLW-4L-7	\$2353	100	12.2	CRW-4L-7	\$2436	108	13.3

To include stainless steel legs & bullet feet on any of the above units add the suffix -SS to the model number and \$80 list.

Portable Ice Bin



not supplied with cross-braced legs as shown

Portable ice bin, extra deep (16") for bottle beer storage. Supplied with 6" stainless steel legs and 4" casters to go where the volume is. Each unit has a drain with a shut off valve.

Size	Model #	Description	List	Wgt.	Cu.Ft.
23"	SCI-MIC-24	21" x 23" Extra Deep Portable Ice bin	\$1129	68	7
29"	SCI-MIC-30	21" x 29" Extra Deep Portable Ice bin	\$1178	72	12
35"	SCI-MIC-36	21" x 35" Extra Deep Portable Ice bin	\$1264	78	16

Hand Sinks

Slimline Series18"
Challenger Series...21"

Features of the Soap & Towel Hand Sinks:

- Sink bowl size 9 1/2" x 11 1/2" x 6"
- 12" & 15" wide (utilizing minimum space)
- Soap dispenser (liquid) built-in
- 'C' fold paper towel dispenser built-in
- 3 1/2" basket drain w/ 1/2 I.P.S. water lines
- 6" deck mount faucet
- Black powder coated cross-braced legs



SC-15-TS-L



SC-15-TS-S

Free standing units with full set of cross-braced legs

Series	Model #	List Price	Wgt. Lbs.	Cu. Ft.
Slimline & Challenger	SC-12-TS-L	\$847	45	4
Slimline & Challenger	SC-15-TS-L	\$861	50	4

Side splashes with full set of cross-braced legs

Series	Model #	List Price	Wgt. Lbs.	Cu. Ft.
Slimline & Challenger	SC-12-TS-S	\$1033	49	4
Slimline & Challenger	SC-15-TS-S	\$1045	54	4

To include stainless steel legs & bullet feet on any of the above units add the suffix -SS to the model number and \$80 list.

Ice Cream Unit

New from SupremeMetal Inc. A cabinet to house a refrigerated ice cream unit.

- Supplied with dipperwell faucet
- Factory cut out sized to specified dimensions
- Black powder coated crossed braced legs – 1 5/8" O.D.



SCIC-42-R

Sectional View

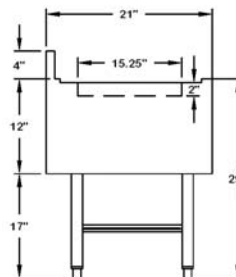

Size	Model #	Description	List	Wgt.	Cu.Ft.
29"	SCIC-30-L	29" with dipperwell on left, must specify ice cream unit cut-out size when ordering	\$1571	60	12
29"	SCIC-30-R	29" with dipperwell on right, must specify ice cream unit cut-out size when ordering	\$1571	60	12
41"	SCIC-42-L	41" with dipperwell on left, must specify ice cream unit cut-out size when ordering	\$1865	80	16
41"	SCIC-42-R	41" with dipperwell on right, must specify ice cream unit cut-out size when ordering	\$1865	80	16

Toll Free : 800-645-2526 Call Today!

Slimline Features:

- 18" from front to back dimension
- 1" I.P.S. drains
- 4" high backsplash
- Black powder coated cross-braced legs

Challenger Features:

- 21" from front to back dimension
- 1" I.P.S. drains
- 2 3/4" rear deck for extra storage
- 4" high backsplash
- Black powder coated cross-braced legs

Slimline (18")					Challenger (21")			
Unit Size	Model #	List Price	Wgt. Lbs.	Cu. Ft.	Model #	List Price	Wgt. Lbs.	Cu. Ft.
12"	SLD-12	\$460	26	4	CRD-12	\$495	28	4
18"	SLD-18	\$520	29	6	CRD-18	\$557	30	6.2
23"	SLD-2	\$604	35	6	CRD-2	\$642	39	7.2
29"	SLD-30	\$652	40	9.3	CRD-30	\$692	41	10.1
35"	SLD-3	\$731	42	9.3	CRD-3	\$773	47	10.1
41"	SLD-42	\$816	48	10	CRD-42	\$867	49	10.5
47"	SLD-4	\$900	55	12.2	CRD-4	\$956	51	13.3
Drainboard with Open Cabinet Base								
18"	SLD-18B	\$853	39	12	CRD-18B	\$953	40	15
23"	SLD-2B	\$1001	45	12	CRD-2B	\$1104	49	15
29"	SLD-30B	\$1115	50	15	CRD-30B	\$1217	51	18
35"	SLD-3B	\$1259	52	18	CRD-3B	\$1365	57	22
41"	SLD-42B	\$1408	58	21	CRD-42B	\$1523	59	26
47"	SLD-4B	\$1559	62	24	CRD-4B	\$1678	63	30
Drainboard with Cabinet Base with Doors								
18"	SLD-18BD	\$1063	49	12	CRD-18BD	\$1261	50	15
23"	SLD-2BD	\$1233	55	12	CRD-2BD	\$1336	59	15
29"	SLD-30BD	\$1372	60	15	CRD-30BD	\$1475	61	18
35"	SLD-3BD	\$1540	62	18	CRD-3BD	\$1647	67	22
41"	SLD-42BD	\$1716	68	21	CRD-42BD	\$1829	69	26
47"	SLD-4BD	\$1889	72	24	CRD-4BD	\$2010	73	30
Beer Drainer w/ 3" x 6" rear column for beer lines								
18"	SLBD-18	\$668	32	6	CRBD-18	\$709	33	6.2
23"	SLBD-2	\$756	38	6	CRBD-2	\$797	42	7.2

To include stainless steel legs & bullet feet on any of the above units add the suffix -SS to the model number and \$80 list.



SLD-2



CRBD-2



CRD-3BD

Wet / Dry Waste Cabinet

Wet / Dry Waste Cabinets have two functions. It has a hand sink with faucet in the rear for liquid waste, and a dry waste chute in the front for trash.

Slimline (18")					Challenger (21")			
Unit Size	Model #	List Price	Wgt. Lbs.	Cu. Ft.	Model #	List Price	Wgt. Lbs.	Cu. Ft.
18"	SLWC-18	\$1386	50	12	CRWC-18	\$1418	57	14
23"	SLWC-2	\$1675	57	13	CRWC-2	\$1718	64	15
29"	SLWC-30	\$1974	64	15	CRWC-30	\$2016	71	18
35"	SLWC-3	\$2084	71	18	CRWC-3	\$2123	77	22
41"	SLWC-42	\$2137	76	20	CRWC-42	\$2181	83	24
47"	SLWC-4	\$2190	81	24	CRWC-4	\$2241	87	30
Wet / Dry Waste Cabinet with Doors								
18"	SLWC-18-DR	\$1596	50	12	CRWC-18-DR	\$1627	57	14
23"	SLWC-2-DR	\$1908	57	13	CRWC-2-DR	\$1951	64	15
29"	SLWC-30-DR	\$2230	64	15	CRWC-30-DR	\$2272	71	18
35"	SLWC-3-DR	\$2365	71	18	CRWC-3-DR	\$2405	77	22
41"	SLWC-42-DR	\$2444	76	20	CRWC-42-DR	\$2488	83	24
47"	SLWC-4-DR	\$2522	81	24	CRWC-4-DR	\$2572	87	30

- Sink bowl size 9 1/2" x 11 1/2" x 6"
- 3 1/2" basket drain w/ 1/2 I.P.S. water lines
- 6" deck mount faucet
- 5" Diameter dry waste chute



CRWC-3

Super Servs

Slimline Series18"
Challenger Series...21"

Blender/Recess/Sink Combo

This unit features a 6" x 11" x 6" dump sink bowl with gooseneck faucet, 1" I.P.S. drain, and a hidden duplex 120v electrical outlet on the underside for blenders.

Series	Model #	List Price	Wgt.	Cu. Ft.
Slimline	SL-RS-12	\$727	20	4
Slimline	SL-RS-15	\$738	21	4
Challenger	CR-RS-12	\$750	21	4
Challenger	CR-RS-15	\$764	22	4

To include stainless steel legs & bullet feet on any of the above units add the suffix -SS to the model number and \$40 list.



Basic Hand Sink

This unit features a 10" x 14" x 10" hand sink bowl with 6" spout faucet, 1-1/2" drain.

Series	Model #	List Price	Wgt.	Cu. Ft.
Slimline	SL-HS-12	\$557	20	4
Slimline	SL-HS-15	\$569	21	4
Challenger	CR-HS-12	\$599	21	4
Challenger	CR-HS-15	\$611	22	4

To include stainless steel legs & bullet feet on any of the above units add the suffix -SS to the model number and \$40 list.



Double Blender Station

This unit features two blender stations for high volume mixing areas. It has a hidden duplex 120v electrical outlet on the underside.

Series	Model #	List Price	Wgt.	Cu. Ft.
Slimline	SL-DB-12	\$436	20	4
Slimline	SL-DB-15	\$449	21	4
Challenger	CR-DB-12	\$466	21	4
Challenger	CR-DB-15	\$476	22	4

To include stainless steel legs & bullet feet on any of the above units add the suffix -SS to the model number and \$40 list.



Universal Undercabinet

We offer this unique option for most of the Super Serv units. You can purchase this unit and add it to any of the above units to make a cabinet base unit. Perfect for extra storage!

Model #	List Price	Wgt.	Cu. Ft.
UU-SS-12	\$546	22	3
UU-SS-15	\$559	26	4

UU-SS-15



Extra Leg Set to make any Super Serv free standing

Slimline	A-49	\$51
Challenger	A-50	\$51
Slimline S/S	A-49-SS	\$91
Challenger S/S	A-50-SS	\$91

Recessed Glass Storage Unit

This unit is designed for the stacking of multiple tiers of glasses. This recess is a perfect addition to a bar with a high volume of mixed drinks. It has a 1" I.P.S. drain.

Series	Model #	List Price	Wgt.	Cu. Ft.
Slimline	SL-GS-12	\$369	20	4
Slimline	SL-GS-15	\$399	22	4
Slimline	SL-GS-18	\$430	24	6
Slimline	SL-GS-24	\$491	28	6
Challenger	CR-GS-12	\$399	20	4
Challenger	CR-GS-15	\$430	22	4
Challenger	CR-GS-18	\$461	24	6
Challenger	CR-GS-24	\$522	28	6

To include stainless steel legs & bullet feet on any of the above units add the suffix -SS to the model number and \$40 list.



CR-GS-15



Blender/Recess w/ Liquid Waste Chute

This unit features a 6" diameter liquid waste chute w/ a 1 1/2" I.P.S. drain and dipperwell faucet. Included is a recessed blender station in front w/ a 120v hidden duplex outlet.

Series	Model #	List Price	Wgt.	Cu. Ft.
Slimline	SL-RW-12	\$580	20	4
Slimline	SL-RW-15	\$594	21	4
Challenger	CR-RW-12	\$614	21	4
Challenger	CR-RW-15	\$626	22	4

To include stainless steel legs & bullet feet on any of the above units add the suffix -SS to the model number and \$40 list.



CR-RW-15



Frozen Drink Machine Stand

The Frozen Drink Machine Stand has a lower working height to accommodate the height of most drink machines for use under the bar. Each unit has a beveled front and a drain in the center rear of the unit. Please verify your drink machine size since there are so many models available.

Model #	Description	List Price	Wgt.	Cu. Ft.
SCFD-18	will hold one drink machine	\$676	45	10
SCFD-30	will hold two drink machines	\$1227	80	18

To include stainless steel legs & bullet feet on any of the above units add the suffix -SS to the model number and \$80 list.



SCFD-18

Trash Receptacle

To help keep the bar area sparkling clean, Slimline & Challenger offers a 12" trash receptacle that can be specified into any line up. Unit is supplied with stainless steel sliding cover. Unit will accept trash receptacle that measures 11" x 20" x 25" tall (15 7/8 gallons). No legs supplied, unit attaches to equipment on either side.

Model #	Description	List Price	Wgt.	Cu. Ft.
SCT-12	trash receptacle	\$504	30	4



SCT-12

Features of the Service Units:

- 21" from front to back dimension
- 4" high backsplash
- All units can be used with Slimline or Challenger series
- Stainless steel legs

The liquor display unit has five tiered steps and is great for high volume bars that need easy access to all of its' most popular liquors. Upgrade the unit with the ultimate in inventory control, a locking cover option.

Unit Size	Model #	List Price	Wgt. (lbs.)	Cu. Ft.
Liquor Display Rack				
12"	CRLR-12	\$883	24	10
12"	CRLR-12-LC (locking cover)	\$1130	28	10
18"	CRLR-18	\$964	29	12
18"	CRLR-18-LC (locking cover)	\$1212	34	12
2'	CRLR-24	\$1046	34	13
2'	CRLR-24-LC (locking cover)	\$1295	38	13
30"	CRLR-30	\$1207	39	14
30"	CRLR-30-LC (locking cover)	\$1456	44	14
3'	CRLR-36	\$1287	44	15
3'	CRLR-36-LC (locking cover)	\$1537	48	15
Closed Glass Rack				
2'	CROR-24 (flat top)	\$961	34	13
2'	CROR-24-CT (drainboard top)	\$1093	40	13
Open Storage Rack				
2'	CROR-24	\$751	34	13
Slanted Liquor Rack				
2'	CRSR-24	\$892	34	13



CRLR-24



CRLR-24-LC



CROR-24-CT
GLASS RACKS NOT INCLUDED



CROR-24
GLASS RACKS NOT INCLUDED

The closed glass racks rack will hold three 20"x 20" x 5 1/2" (sizes of glass racks may vary slightly). This unit has either a flat top or a corrugated top with a 1" drain in the center.

The open glass rack unit will hold four 20"x 20" x 5 1/2" (sizes of glass racks may vary slightly).



CRSR-24

The slanted liquor/glass rack will hold two 20"x 20" x 5 1/2" (sizes of glass racks may vary slightly) in the under-cabinet and display one glass rack on the top slanted section.

Toll Free : 800-645-2526 Call Today!

*Does your customer have an odd shaped bar?
Does he need to use every inch available for workspace?*

The Slimline and Challenger filler units are just the thing to complete the line up. These units come in both series so that they will line up neatly. We offer a large variety of angles from 30° through a full 90° corner with a leg assembly. These units are designed to be installed in the field by connecting them to the adjoining equipment creating a seamless underbar layout.

These units come standard with 4" high backsplash, pre-drilled holes on the sides for easy installation. The full corner units come with a single leg set for extra sturdiness.



**CRF-90CR
Rear Filler (Overhead View)**

Angle	Slimline Model #	Challenger Model #	List Price	Wgt. Lbs.	Cu. Ft.
Front Fill-Ins					
30°	SLF-30F	CRF-30F	\$377	15	8
45°	SLF-45F	CRF-45F	\$377	15	8
60°	SLF-60F	CRF-60F	\$377	15	8
90°	SLF-90F	CRF-90F	\$377	15	8
Rear Fill-Ins					
30°	SLF-30R	CRF-30R	\$377	15	8
45°	SLF-45R	CRF-45R	\$377	15	8
60°	SLF-60R	CRF-60R	\$377	15	8
90°	SLF-90R	CRF-90R	\$377	15	8
Corner Rear Filler					
90	SLF-90CR	CRF-90CR	\$575	30	8
Corner Front Filler					
90	SLF-90CF	CRF-90CF	\$575	30	8



**SLF-90F
Front Filler**

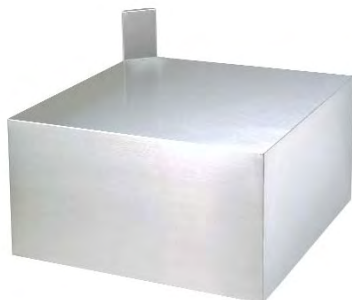

**SLF-90CF
Front Corner Filler**



**CRF-90CR
Corner Rear Filler**

Features of the SRK series Speed Rails:

- Available in 1' to 8' lengths
- Keyhole installation
- Raised one-piece front moulding for strength and durability
- Add-on to Slimline & Challenger series to attain "that custom look"
- Optional add-on second tier (removable)



SRK-2



SRKD-2

The SRK series is a Full Length Heavy Duty speed rail that is available in 1' to 8' lengths. SRK's can be modified in length or made wider to accommodate 1/2 gallon bottles (see pricing below). To have units predrilled for ease of installation of SRK's (see pricing below).

Add \$37 per unit to make an odd size SRK- supply actual overall length

Add \$60 per unit to make an SRK wider to accommodate 1/2 gallon bottles

Add \$63 per unit to have units predrilled at factory for ease of SRK installation (include prefix **-PD** to the model #)

Single Tier

Size	Model #	List Price	Wgt. Lbs.	Size	Model #	List Price	Wgt. Lbs.	Size	Model #	List Price	Wgt. Lbs.
12"	SRK-12	\$102	4	29"	SRK-30	\$111	8	59"	SRK-5	\$137	13
15"	SRK-15	\$104	4	35"	SRK-3	\$113	9	71"	SRK-6	\$152	14
18"	SRK-18	\$106	5	42"	SRK-42	\$118	10	83"	SRK-7	\$178	15
23"	SRK- 2	\$109	5	47"	SRK-4	\$123	11	95"	SRK-8	\$185	16

Double Tier (Integral)

Size	Model #	List Price	Wgt. Lbs.	Size	Model #	List Price	Wgt. Lbs.	Size	Model #	List Price	Wgt. Lbs.
12"	SRKD-12	\$175	8	29"	SRKD-30	\$271	16	59"	SRKD-5	\$350	26
15"	SRKD-15	\$179	9	35"	SRKD-3	\$285	18	71"	SRKD-6	\$385	28
18"	SRKD-18	\$208	10	42"	SRKD-42	\$302	20	83"	SRKD-7	\$431	30
23"	SRKD-2	\$245	13	47"	SRKD-4	\$314	22	95"	SRKD-8	\$459	32

Hang-On Second Tier

The speed rail shown is a Hang-On style SRK. This rail is designed to hang on the first tier of any SRK (not recommended for use with any other manufacturers speed rail) To handle increasing liquor sales you can double your liquor storage. Hang-On can be removed during the off season, allowing the bartender more room. The end result is flexibility with the durability of an SRK.



SR-2H

Size	Model #	List Price	Wgt. Lbs.
12"	SR-12H	\$115	4
15"	SR-15H	\$119	5
18"	SR-18H	\$125	6
23"	SR-2H	\$128	7
29"	SR-30H	\$137	8
35"	SR-3H	\$146	9
42"	SR-42H	\$152	9
47"	SR-4H	\$156	10

Single Tier

Size	Model #	List Price	Wgt. Lbs.
------	---------	------------	-----------

BK series Keyhole installation (stainless steel single tier)

14"	BK-15	\$75 ea.	4
22"	BK-2	\$77 ea.	5
28"	BK-30	\$85 ea.	6
34"	BK-3	\$91 ea.	6
46"	BK-4	\$109 ea.	8

BK series Strap Hanger Installation (stainless steel single tier)

14"	BS-15	\$93 ea.	5
22"	BS-2	\$98 ea.	6
28"	BS-30	\$109 ea.	7
34"	BS-3	\$113 ea.	7
46"	BS-4	\$137 ea.	9

Lock-Up Style BK series Keyhole Installation (stainless steel single tier)*

22"	LCBK-2	\$159 ea.	13
34"	LCBK-3	\$180 ea.	15
46"	LCBK-4	\$205 ea.	18

* When underbar units exceed 4' use multiple Lock-Ups allowing 1/2" between speed rails for lock clearance. Price includes BK series speed rail & cover.

Black Beauty series Keyhole Installation (black powder coated single tier)

22"	BB-2	\$47 ea.	5
34"	BB-3	\$57 ea.	6

Double Tier

Size	Model #	List Price	Wgt. Lbs.
------	---------	------------	-----------

Double Tier BK series Keyhole Installation (stainless steel double tier)**

14"	DT-15	\$143 ea.	7
22"	DT-2	\$146 ea.	8
28"	DT-30	\$156 ea.	10
34"	DT-3	\$164 ea.	11
46"	DT-4	\$197 ea.	18

Lock-Up Style Double tier Keyhole Installation (stainless steel double tier)*

2'0"	LCDT-2	\$227 ea.	15
3'0"	LCDT-3	\$257 ea.	19
4'0"	LCDT-4	\$295 ea.	27

* When underbar units exceed 4' use multiple Lock-Ups allowing 1/2" between speed rails for lock clearance. Price includes BK series speed rail & cover.

**Keyhole only installation recommended for all double tier speed rails due to weight of liquor bottles.

Molded Plastic

* These units are packed per carton only, to break the carton there will be an additional charge of \$25 list.

Kwik-Store single tier injection molded (black plastic)

Size	Model #	List Price	Packed per ctn	Wgt. Lbs. per ctn
23"	KS-2 (strap)*	\$47 ea.	6	16
23"	KS-2K(keyhole)*	\$26 ea.	6	12

Stainless Steel strap hangers:

Model #	PR-STRAPS - One pair	\$28
---------	----------------------	------



BK-2



BS-2



BB-2



DT-30



LCDT-2



KS-2

PR-STRAPS



KS-2K

Accessories







SupremeMetal is constantly engaged in a program of improving our products. Therefore, we reserve the right to change our specifications without prior notice.





<p>Continuous Waste Assemblies</p>  <p>A-2 2 compartment \$49 A-3 3 compartment \$59 A-4 4 compartment \$73</p>	<p>S/S Open Waste Chute</p>  <p>5 1/2" diameter (inside) A-6 installed in unit \$241 A-6-L loose \$118</p>	<p>S/S Liquid Waste Chute w/ s/s basket</p>  <p>A-7 installed in unit \$299 A-7-L loose \$179</p>	<p>Condiment Rack Slimline & Challenger Series</p>  <p>← 23" →</p> <p>A-8 backsplash mount \$296</p>
<p>1" Waste Outlets</p>  <p>packed 6 per carton</p> <p>A-10 1" chrome \$78 ct</p>	<p>1 1/2" Waste Outlets</p>  <p>packed 6 per carton</p> <p>A-11 1 1/2" stainless \$78 ct</p>	<p>Overflow Pipes (S/S) packed 6 per carton</p>  <p>A-12 1" old style \$78ct A-13 1 1/2" new style \$78ct</p>	<p>Chrome Towel Ring</p>  <p>A-15 packed loose \$37</p>
<p>Perforated Basket for all 10x14x10 Sinks</p>  <p>A-16 10x14x10 sink size \$186</p>	<p>Perforated Basket for all 9 1/2 x 11 1/2 x 6 Sinks</p>  <p>A-17 9 1/2 x 11 1/2 x 6 sink size \$167</p>	<p>Perforated Basket for all 6 x 11 x 6 Sinks</p>  <p>A-23 6 x 11 x 6 sink size \$163</p>	<p>Replacement 4-Paks For Explorer & Older Series</p>  <p>5" ← → 16 1/2"</p> <p>packed 6 per carton @ 11 lbs.</p> <p>A-18 4-pak bottle holder \$174ct</p>
<p>Hold-Ins</p>  <p>5 1/4" ← → 5 1/4"</p> <p>packed 6 per carton @ 6 lbs.</p> <p>A-19 single bottle holder \$60ct</p>	<p>3-Pak Bottle Rack For Current Series(our equip only)</p>  <p>5 1/4" ← → 15 7/8"</p> <p>packed 6 per carton @10 lbs.</p> <p>A-20 3-pak bottle holder \$162ct</p>	<p>Replacement Rubber Grommets for Overflow pipes packed 12 per carton</p>  <p>A-21 1" old style \$48ct A-22 1 1/2" new style \$60ct</p>	<p>Blender Shelf 12" x 18" w/ Duplex Outlet</p>  <p>A-24 add on blender shelf \$114</p>
<p>S/S Partitions for Ice Bins</p>  <p>14 3/4" →</p> <p>A-38 8" high partition \$51 A-39 11" high partition \$51 A-40 15" high partition \$51</p>	<p>S/S False Bottom for Ice Bin</p>  <p>A-41 fits 2' ice bin \$78 A-42 fits 30" ice bin \$85 A-43 fits 3' ice bin \$93 A-44 fits 42" ice bin \$100 A-45 fits 48" ice bin \$118</p>	<p>Replacement Utensil Bin</p>  <p>discontinued</p> <p>15 1/2" ← → 20 3/4"</p> <p>UB-4 for server station drawer</p>	<p>Replacement Soap Pump</p>  <p>A-90 soap pump \$47</p>

Toll Free : 800-645-2526 Call Today!

Accessories

SupremeMetal is constantly engaged in a program of improving our products. Therefore, we reserve the right to change our specifications without prior notice.

<p>Deck Mount Faucets</p>  <p>6" spout</p>  <p>12" spout</p> <p>Standard Faucets</p> <p>A-25 6" spout \$80 A-26 12" spout \$85</p> <p>Heavy Duty Faucets (upgrade)</p> <p>A-27 6" spout \$217 A-28 12" spout \$232</p>	<p>Splash Mount Faucets</p>  <p>6" spout</p>  <p>12" spout</p> <p>Standard Faucets</p> <p>A-31 6" spout \$85 A-32 12" spout \$91</p> <p>Heavy Duty Faucets (upgrade)</p> <p>A-27-S 6" spout \$222 A-28-S 12" spout \$236</p>	<p>Goose Neck Faucets</p>  <p>deck mount</p>  <p>splash mount</p> <p>Standard Faucets</p> <p>A-36 deck mount \$80 A-37 splash mount \$85</p> <p>Heavy Duty Faucets (upgrade)</p> <p>A-35 deck mount \$205 A-35-S splash mount \$236</p>	<p>Wrist Handles for Faucets (upgrade from reg faucet)</p>  <p>Standard</p>  <p>Heavy Duty</p> <p>For use with Standard Faucets</p> <p>A-83 deck mount \$68 A-84 splash mount \$68</p> <p>For use with Heavy Duty Faucets</p> <p>A-85 deck mount \$78 A-86 splash mount \$78</p>
---	---	--	---

<p>Dipper Well Faucet</p>  <p>A-33 installed \$114 A-33-L loose \$73</p>	<p>Water Filler Faucet</p>  <p>Push back style will fill up to a 8" high pitcher.</p> <p>A-34 installed \$190 A-34-L loose \$145</p>	<p>Goose Neck Deck Mount w/ Melt Down Spray Nozzle</p>  <p>A-29 loose \$370 A-30 installed \$424</p>	<p>4" Swivel Casters in lieu of bullet feet (per unit)</p>  <p>A-46 4" casters \$143</p>
---	---	---	--

<p>S/S Sliding Covers For SL & CH Series</p>  <p>These covers are designed to fit the Slimline & Challenger series only.</p>	<p>SSC-12 for 12" ice bins \$55 SSC-15 for 12" ice bins \$65 SSC-23 for 24" ice bins \$80 SSC-29 for 30" ice bins \$96 SSC-35 for 36" ice bins \$106 SSC-47 for 48" ice bins \$133 SSC-PT for pass thru bin \$123</p>	<p>Misc Accessories</p> <p>A-51 - 6" hole in drainboard surface for waste chute installation \$113</p> <p>A-47 - Export Charge (shell crate over standard carton) ... Add 20%</p>
--	--	--



3125 Trotters Pkwy
Alpharetta, GA 30004

Toll Free: 800-645-2526
Local: 770-740-6000
Fax: 770-740-6010

Representative Territories

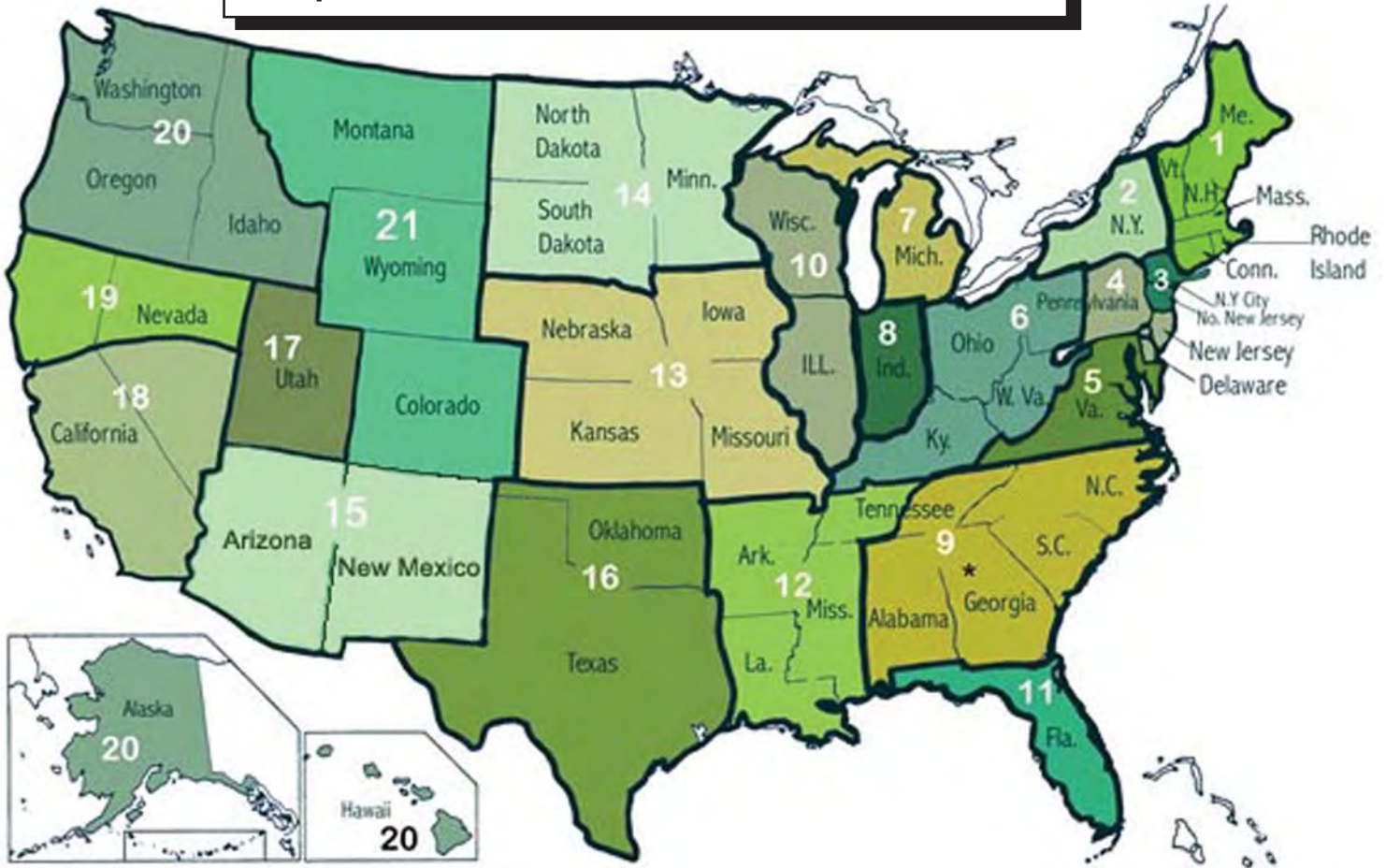

- | | |
|--------------------------------|---|
| 1. MPH Group | Maine, Vermont, New Hampshire, Mass, Conn, Rhode Island |
| 2. Bowerman & Assoc. | New York State (except NYC Metro) |
| 3. Pecinka Ferri Associates | No. New Jersey, Manhattan, Long Island, Queens, Staten Island, Brooklyn, Bronx, Westchester |
| 4. Schmid Dewland Assoc. | So. New Jersey, E. Pennsylvania, Delaware |
| 5. Schmid Wilson Group | Virginia, Maryland, Washington D.C. |
| 6. Bauer Marketing Group | Kentucky, Ohio, W. Pennsylvania, W. Virginia |
| 7. HGA Group | Michigan |
| 8. Allied Tech | Indiana |
| 9. Master Marketing | Alabama, Georgia, E. Tennessee, North Carolina & South Carolina |
| 10. Riordan-Beshilas Marketing | Illinois, Wisconsin |
| 11. GMR Marketing | Florida |
| 12. Young Equipment Solutions | W. Tennessee, Mississippi, Louisiana, Arkansas |
| 13. Katzman Grossman Baker | Iowa, Nebraska, Kansas, Missouri |
| 14. Scotlyn Sales | Minnesota, North & South Dakota |
| 15. Pro Reps of Arizona | Arizona & New Mexico & El Paso, TX |
| 16. Munn Marketing | Texas, Oklahoma |
| 17. Wasatch Mountain Mktg. | Utah |
| 18. Auerbach-Phelan Group | S. California, S. Nevada |
| 19. Market Smart | N. California, N. Nevada |
| 20. Pro Pacific Agents | Alaska, Hawaii, Idaho, Oregon, Washington |
| 21. Baltzer & Assoc. | Colorado, Montana & Wyoming |
| 22. H.D. Sheldon & Assoc. | Caribbean, Germany, South America (any export) |

Toll Free : 800-645-2526 Call Today!

Manufacturer Representatives

Organization	Representative	Office #	Fax #	Territory
ALLIED TECH	<i>Phil Powell, John Summit & John Durbin</i>	317-887-2020	317-887-2715	Indiana
Auerbach-Phelan Group	<i>Paul Auerbach & Randy Phelan</i>	818-505-0028	949-443-9655	Southern California & Southern Nevada
BALTZER & ASSOC www.baltzerassociates.com	<i>Terry Baltzer & Steve Vassau</i>	800- 255-3419	303- 480-1454	Colorado, Montana & Wyoming
BAUER MARKETING GROUP www.bauermarketing.com	<i>Bruce Bauer, Greg Oplinger & Rob Sands John Green</i>	513-281-4600 412-487-6282	513-281-4603	Ohio, Western Pennsylvania, Kentucky West Virginia
BOWERMAN & ASSOC. www.ebowerman.com	<i>Ron Bowerman, Mike Hayes & Jeff Youker</i>	315-453-5288	315-422-8875	Upstate New York
GMR MARKETING	<i>Jerry Renda Michael Richardson</i>	954-341-0264 352-481-5228	954-345-0139 352-481-5230	South Florida Panhandle & North Florida
H.D.Sheldon & Co. www.hdsheldon.com	<i>Rob Metros Matthew Pinsly</i>	212-924-6920	212-627-1759	Any Country outside the U.S. (export)
HGA GROUP www.hgagroup.com	<i>John McCurdy, Rod Johnson & Ed Gregory</i>	734-453-5060	734-453-5818	Michigan
KATZMAN/GROSSMAN/BAKER www.kgb1.com	<i>Tom Grossman & Brian McGonagle Steve Baker & Dave Appenbrink</i>	314-965-4921 913-888-6324	314-965-4572 913-599-4517	Missouri & Iowa Nebraska & Kansas
MARKET SMART www.marketsmartinc.com	<i>Jim Macchi, Vic Enos, Rob Nasty & Tim Nasty</i>	925-475-2218	925-846-2602	Northern California & Northern Nevada
MASTER MARKETING www.master-marketing.com	<i>Jerry Hennebaul, Danny Graham & John Varner Wilson Sawyer Jr. Bruce Marlette Jack & Lisa Lewis</i>	800-241-4878 205-910-3056	770-409-1881 205-823-6569	Georgia Alabama E. Tennessee N. & S. Carolina
MPH GROUP www.themphgroup.com	<i>Joe Burbine, Joe McDonald & Don Perry</i>	781-575-9020	781-575-9164	Maine, Mass., Vermont, N.H., R.I. & CT
MUNN MARKETING www.munn-mktg.com	<i>Lewis Munn, Zach Munn, Terry Mathis & Steve Ricketson Thurston Munn</i>	972-732-0057 405-395-9710	972-248-2161 405-395-9709	Texas Oklahoma
PECINKA FERRI ASSOCIATES www.pecinkaferrri.com	<i>Ed Pecinka , Joe Ferri & Cliff MacTavish</i>	973-812-4277	973-812-4284	New York City, Long Island & Northern New Jersey
PRO-PACIFIC AGENTS	<i>Mike Walker & Rick Burby Robin Oury & Larry Jaeck Ben Sikora</i>	360-546-0411 425-827-7279 808-922-4338	360-546-0301 425-828-0464	Oregon Washington, Idaho & Alaska Hawaii
PROFESSIONAL REPS OF AZ www.prorepsaz.com	<i>Brian Bauer & Bob Toloskiewich</i>	602-995-8922	602-864-1754	Arizona, New Mexico & El Paso, Tx
R & B MKTG GROUP	<i>Tim Riordan & Bill Beshilas</i>	630-904-4746	630-922-9884	Illinois & Wisconsin
SCHMID-DEWLAND ASSOC. www.schmidewland.com	<i>Mark Schmid, Tim Schmid, Brian Rae & Mark Stanton John Timalonis</i>	856-783-3400 610-395-8700	856-783-7375 610-395-1458	Southern New Jersey & Delaware Eastern Pennsylvania
SCHMID WILSON GROUP www.theswg.com	<i>Rob Schmid, Bill Lentz, Pete Padgett & Pete Wilson Don Boone</i>	410-998-9191 804-794-7492	410-998-9195 804-794-3931	Maryland, District of Columbia & N. Virginia South & Western Virginia
SCOTLYN SALES www.scotlyn.com	<i>Scott Weisman, Lynn Clements & Dick Cunningham</i>	952-921-0373	952-921-0374	Minnesota , North & South Dakota
WASATCH MTN. MKTG. INC.	<i>Jeff Crossley</i>	801-328-0712	801-328-0742	Utah
YOUNG EQUIPMENT SOLUTIONS www.commkitchens.com	<i>Richard Young ,Alison Young & Charlotte Ellzey Shirley Simpson & Julie Perrigin Brenda Brooks Tim Whitey</i>	318-869-0841 601-426-6325 501-837-6195 615-336-3436	318-869-0576 601-649-4406 501-834-6275 615-791-5804	Louisiana Mississippi Arkansas W. Tennessee

Warranty Information

Terms and Conditions (SHORT FORM)

All previous prices and discounts are hereby withdrawn.

- All prices are F.O.B. factory.
- 1% discount-10 days: net- 30 days.
- All prices, specifications and discounts subject to change without notice. Prices listed herein do not include Federal Excise, Municipal, or other use tax.
- Not responsible for any damage while in the hands of a carrier. (For any damage and loss while in transit, file claim against carrier promptly.)
- Merchandise shipped open account to those furnishing satisfactory credit references.
- Quotations, unless otherwise stated, are for 30 day acceptance.
- Returns:
 - A 35% to 40% handling charge will be applied to all authorized returns.
 - A 40% to 45% handling charge will apply to all unauthorized returns.
 - Actual restocking charges to be determined upon return and inspection of merchandise.
- Limited 5-year Sink Bowl Warranty for all units containing drawn sink bowls \$6.00 list.
- Standard one year manufacturers warranty for all other units.
- Orders for special items are not subject to cancellation without our prior written consent.
- Our permission must be obtained before defective merchandise is returned. Incoming freight or express charges may be collected and exchanges will be shipped prepaid.
- On return shipments that we sanction, where orders have been correctly filled out and are not defective, the incoming freight or express freight charges must be prepaid. Credit will then be issued, less a reasonable handling charge and less whatever expense is necessary to put goods in saleable condition.
- We are not responsible for delays in delivery which are beyond our control such as fires, strikes, delays in transportation or any contingencies of similar character.
- All orders subject to acceptance at our office.
- Possession of price list does not constitute an offer to sell.

General Shipping Information

1. We reserve the right to ship via carriers which in our opinion are the most efficient. We will follow customer routing if possible.
2. Unless specified, all orders shipped will be "Freight Collect".
3. All "Drop Shipments" will be shipped "Prepaid & Bill".

PREPAY & ADD FREIGHT CHARGES

- Estimated freight charges added to an invoice will include a nominal administrative charge per freight bill.

SupremeMetal 5 Year Limited Sink Bowl Warranty

Manufacturer warrants that the DEEP DRAWN sink bowls of this unit when used for normal commercial purposes shall be free from leaks resulting from defective material or workmanship only in accordance with the following terms and conditions:

1. To original user only. Bill of Sale must be submitted with all claims.
2. Claims made to manufacturer within 30 days of discovery of defect.
3. Subject to manufacturer's inspection.
4. Manufacturer may repair or replace unit free of charge.
5. Replacement will be current compatible unit, but dimensions may vary.
6. Defective units, if necessary, will be freight prepaid by shipper for inspection. Replacement units, if necessary will be freight prepaid by manufacturer.
7. MANUFACTURER'S LIABILITY LIMITED TO DEEP DRAWN SINK BOWL LEAKAGE ONLY.
8. MANUFACTURER NOT RESPONSIBLE FOR DAMAGE, OR BUSINESS LOSS OF ANY KIND RESULTING FROM DEFECT IN THE UNIT, OR FOR ANY CHARGES RELATED TO REMOVAL OF DEFECTIVE UNIT OR INSTALLATION OF REPLACEMENT UNIT.
9. Only catalog production units are covered in this warranty. Warranty excludes custom built equipment or DRAWN bowls modified for heating devices.
10. WARRANTY IS VALID FOR 5 YEARS FROM DATE OF SALE.

GENERAL NOTE: Warranty Charge will appear on all invoices for seamless drawn sinks at \$6.00 list per unit. If warranty is declined unit will not be considered for warranty work. Under no circumstances will unit be warranteed if Limited Bowl Warranty has been deducted or has not been paid on original invoice..

WARRANTY VOID IF:

1. Unit has been transferred from the original user.
2. Unit installed by person other than a licensed plumber or not in compliance with local code.
3. Unit is altered or modified in any way.
4. Unit has any accessories parts affixed to units which are not recommended or installed by manufacturer.
5. Unit is installed outside the continental United States.
6. USE OF CHEMICALS OR DETERGENTS NOT IN COMPLIANCE WITH THE MANUFACTURER'S DIRECTIONS OR NOT RECOMMENDED FOR USE ON STAINLESS STEEL (This includes CHLORINE or any CHLORINE derivative products)
7. This warranty may be rescinded by manufacturer without prior notice.
8. This warranty is the exclusive warranty provided by the manufacturer and is in lieu of all other warranties expressed or implied, including the warranty or merchantability and fitness for a particular purpose. Any claim under this warranty must be made in writing to SupremeMetal.

SupremeMetal is constantly engaged in a program of improving our products. Therefore, we reserve the right to change our specifications without prior notice.